

დიზაინი & მონტაჟი

კედელი

მოდულური კედლის
გათბობა გაგრილების
პანელები

Modular Wall



2/2023

PDF



www.variotherm.com

VARIOTHERM



1 PRINCIPLES ◀

- 1.1 Comfort..... 4
- 1.2 Energy savings..... 5
- 1.3 Adapts to suit your home 5
- 1.4 Cooling..... 5
- 5. Temperature variations/wall structure..... 6

2 PREPARATION ◀

- 2.1 Warranty conditions 8
- 2.2 Information on standards 8
- 2.3 Fire protection 8
- 2.4 Load bearing walls 8
- 2.5 Transport/storage of goods..... 8
- 2.6 Tools..... 9
- 2.7 Visible side/rear side of the ModularPanel..... 9
- 2.8 Humidity..... 9
- 2.9 Maximum flow temperature and dew point 9

3 SUBSTRUCTURE ◀

- 3.1 General 10
- 3.2 Vertical stud construction (standard variant) 10

1 PRINCIPLES

Variotherm recommends a combination of floor, wall and ceiling. In general, walls offer the largest exchange area, which is why wall heating/cooling systems ensure that people can easily feel the radiant heat.

For hot summer days, we recommend wall and/or ceiling cooling. Instead of hot water, cooled water flows through the pipes at a temperature of 16-20 °C. Rooms are cooled to a comfortable temperature, in complete silence and without forced air.

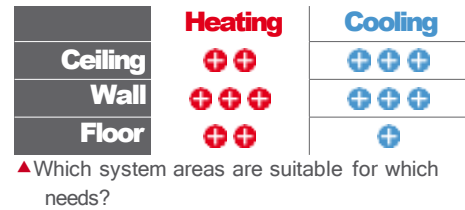

1.1 Comfort

Comfort is not only created through a certain air temperature in the room. The temperature of the surfaces enclosing the room is of equal importance. The felt temperature is roughly consistent with the arithmetic mean of both temperatures.

When does a person feel comfortable?

A person only feels comfortable when the basic equation of "thermal comfort" is optimally fulfilled:

$$\text{heat generation} = \text{heat emission}$$

Heat production
heat loss

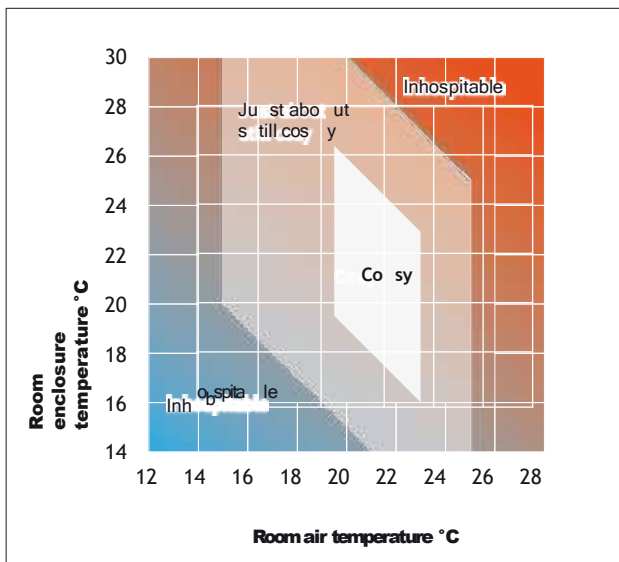

▲ Zone of cosiness

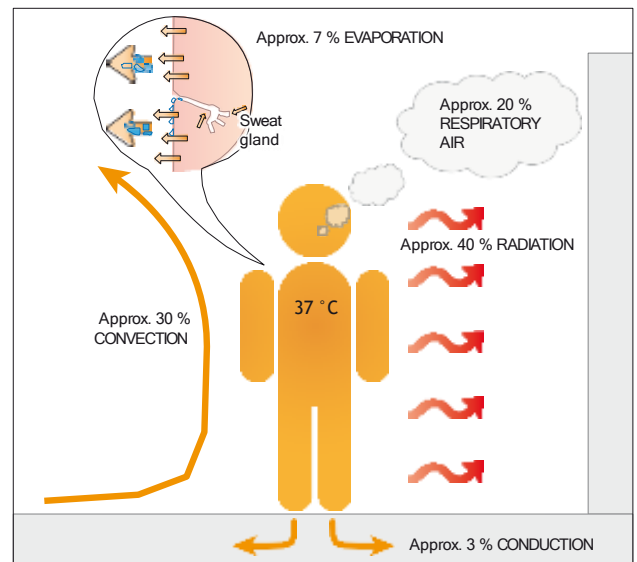

▲ Human heat balance

In this context, it is important that heat loss from the human body is as evenly distributed in all directions as possible. We feel uncomfortable if too much heat is lost in one particular direction (cold surfaces, draughts) or the heat loss is prevented in one direction (hot surfaces or vapour-tight, thick clothing).

The lower the inside air temperature is, the warmer the surrounding surfaces (wall surfaces, floor and ceiling, as well as doors and windows) must be to ensure cosiness.

Compared to other heating systems, the Modular Wall significantly increases cosiness. The installation of surface heating on the inside of the exterior wall, especially under windows, can largely cancel out the unpleasant effects from the radiation exchange between your body and cold exterior walls and windows. You can set the room temperature lower than you would with convection heating, since radiant heat raises the perceived air temperature.

1.2 Energy savings

A lowered room air temperature along with increased cosiness significantly minimises energy losses. The approximate heating cost savings per 1 °C lower room air temperature are approx. 6%. The low room air temperature has the additional great physiological advantage of significantly increasing the absorption of oxygen in the body.

The wall heating system is ideal for use with low-temperature energy sources such as condensing boilers, heat pumps and solar collectors because it operates with low surface and heating medium temperatures.

With Variotherm wall heating you can achieve energy savings of up to 30% compared to conventional heating systems.

1.3 Adapts to suit your home

The Variotherm modular wall heating surfaces can be individually adapted to suit the local situation (windows, doors etc.). Visible radiators under the windows are a thing of the past.

1.4 Cooling

One reason for the frequent lack of satisfaction with air-conditioning systems is the inadequacy of the thermal ambient conditions in the air-conditioned rooms. Most frequently mentioned is the presence of uncomfortable forced air. Cooling via wall surfaces offers the advantage of gentle radiation exchange between the cooled wall surface and the human body. In addition, the room temperature is reduced to a comfortable level.

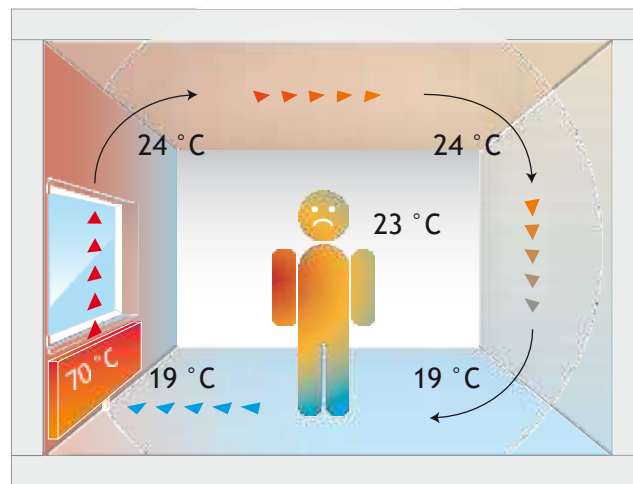

▲ Discomfort with radiators

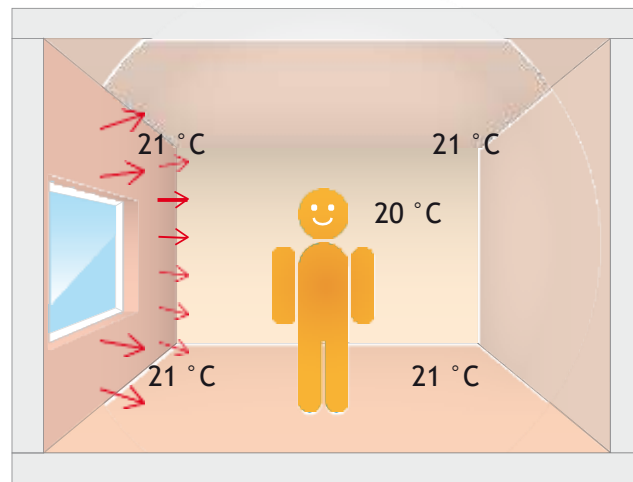

▲ Comfort with wall heating

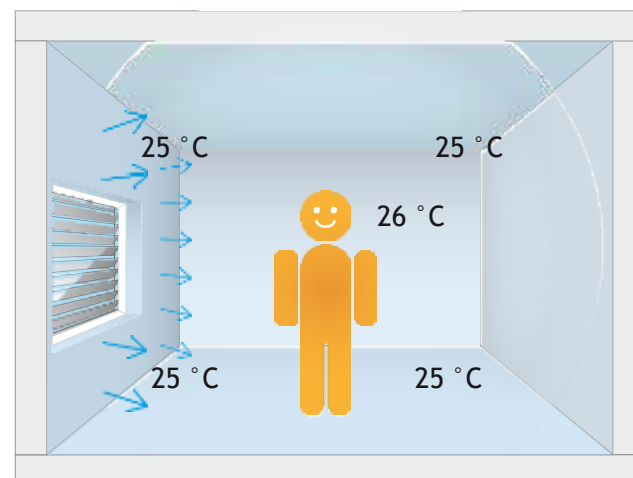

▲ Comfort with wall cooling

Effects of surface cooling on the room

When a wall surface is cooled, all warmer objects in the room (floor, interior walls, people, equipment, etc.) radiate heat into this cooled surface. This loss of heat through radiation leads to a reduction in the surface temperature of these objects, thus providing a cooling effect. The ambient air in the room is also cooled to a comfortable level.

Cooling mode

Based on experience, cooling makes sense at a room temperature $\geq 26\text{ }^{\circ}\text{C}$. To achieve a noticeable effect and suitably cool the body, a reduction of the wall surface temperature to approx. $19\text{--}22\text{ }^{\circ}\text{C}$ is recommended.

Economy

The necessary cooling performance can be better distributed with water than with air. The pumping costs for surface cooling systems are usually significantly lower than the costs incurred by using fans. A 100 percent coverage of the cooling load, as per VDI 2078 (calculation of the cooling load for air-conditioned rooms), is possible in buildings designed for low energy consumption with shadowing equipment and low internal loads.

One of the major advantages of wall cooling/heating systems is the low additional investment costs. A single system is used for the cooling and heating modes: the same wall surface, same piping system and the same heating/cooling distribution manifold with supply lines and circulation pump. The generation of cooling (chiller/heat pump/cooling from the floor and ground water) is planned in parallel to the heating unit. Many modern heat pumps already allow switching from heating to cooling mode - without major extra costs. Ambient sources of cooling (deep boreholes, ground collectors, wells ...) can also be used - at zero cost.

Combination of displacement ventilation and surface cooling

Surface cooling does not replace an air-conditioning system with regard to dehumidification and ventilation. Displacement ventilation is an air-conditioning system with low air exhaust speeds and laminar flow of the escaping air at the exhaust vents. Low turbulence in the air flow through the room is achieved through the type of ducting in the room, blowing of air at floor level at a slightly subnormal temperature and extraction of the exhaust air at the ceiling level. This type of displacement flow, known as "displacement ventilation" can achieve almost complete freedom from draughts. The combination of wall cooling and displacement ventilation allows significantly higher cooling performance to be achieved compared to using only a displacement ventilation system, without exceeding thermally comfortable air speeds. If the supplied air is dehumidified then low wall surface temperatures, and thus high radiant cooling performance, can be achieved without the formation of condensation, even on hot and humid days.

1.5 Temperature variations/wall structure

Various different wall fittings at a wall surface temperature of $30\text{ }^{\circ}\text{C}$ and a standard outdoor (air) temperature of $-14\text{ }^{\circ}\text{C}$

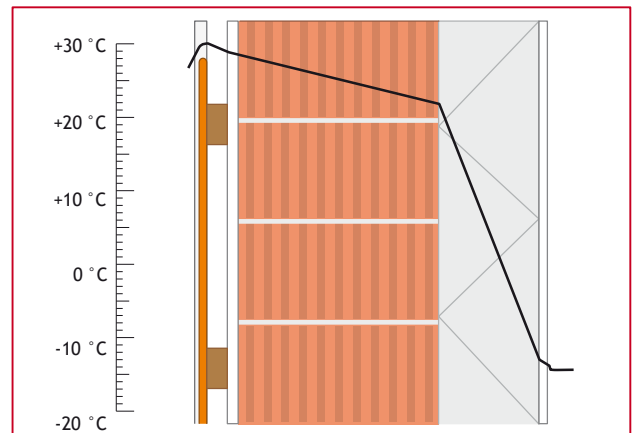

▲ Example with solid brick, structure from the inside out:

- Modular Wall
- recessed formwork/installation level
- 300 mm vertically perforated brick
- 160 mm thermal insulation
- exterior plaster/coat of paint

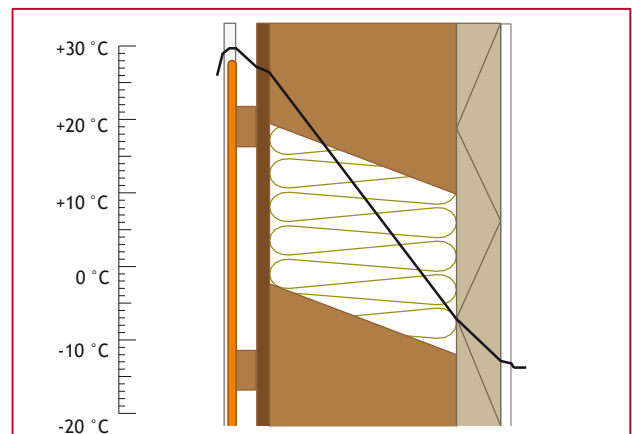

▲ Example with timber frame construction (diffusion-open), structure from the inside out:

- Modular Wall
- recessed formwork/installation level
- OSB 4 18 mm (sealed airtight)
- 240 mm timber frame and cellulose insulation
- 60 mm wood insulating fibreboards
- exterior plaster/coat of paint

Advantages Modular r Wall

- › Heating, cooling and finished wall all in one!
- › Ideal for timber-framed buildings, pre-fabricated houses, attics and renovation
- › Heating system: large-surface, extremely energy-saving low temperature system
- › Cooling system: silent, no draughts, energy-efficient
- › A totally flexible panel system: fulfils all building requirements
- › Gypsum fibreboards and components which have been tested for their healthy building properties
- › Fire protection assessment (IBS Linz)

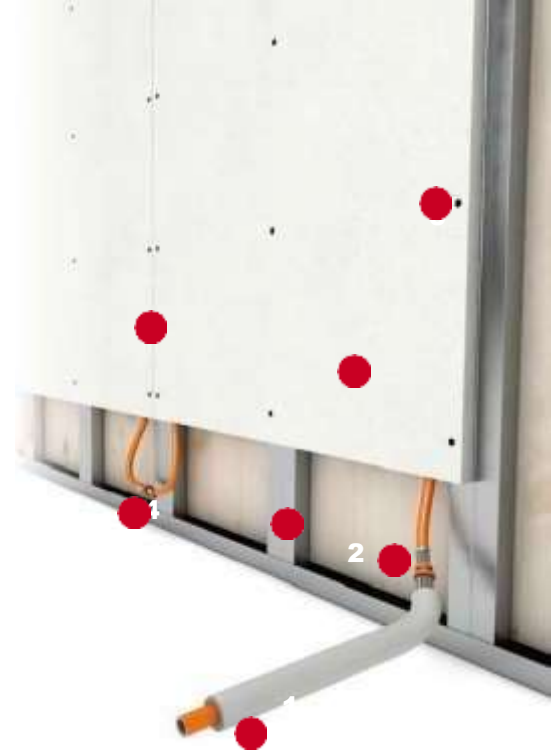

- Substructure must be prepared on-site (wood or metal)
- ModularPanel
- Dry wall screw
- Joint adhesive
- Press-fit couplings
- Pre-insulated VarioModular pipe 16x2

1.6 Description and advantages of the Modular Wall

The Variotherm Modular Wall is an extremely energy efficient heating and cooling system. As a flexible panel system, it is pre-assembled for installation in walls and pitched ceilings. Here, heating, cooling and complete wall are perfectly combined in a single product. The desired room temperature is achieved by using hot and cold water circulation to make sure you feel completely comfortable all year round.



2 PREPARATION

1. Warranty conditions

If installed or commissioned incorrectly, all claims on the basis of the manufacturer's warranty and guarantee become void.

This brochure (version dated 2/2023) is intended for authorised qualified personnel and constitutes part of our warranty!

All previous versions become invalid upon release of a new version! For the latest version please refer to the QR Code on the title page or www.variotherm.com

Local, geographic and climatic regulations/standards for cooling, heating and electrical installations must be observed!

2. Information on standards

The validity of the standards referred to in these installation instructions was last checked on 16.02.2023.

If necessary, amendments to standards must be checked.

3. Fire protection

With respect to fire protection, the Variotherm Modular-Panels 18 mm with integrated VarioModular pipes are equivalent to a 125 mm FERMACELL gypsum fibre board without pipes (Test IBS-Linz No. VFA2001-0389-01, fire protection assessment file number 10111710).

Please observe the relevant FERMACELL regulation and FERMACELL fire protection assessments. The Variotherm acoustic ModularPanels provide no fire protection! See also Chapter

4. Load bearing walls

Caution: With load bearing wall construction the Variotherm ModularPanels must not carry any static ceiling loads and must not be used for building reinforcement.

2.5 Transport/storage of goods

Pre-insulated VarioModular pipes

Leave the VarioModular pipes in the box as long as possible to avoid damage from dents and scratches. Damage of this kind has a detrimental effect on the creep behaviour.

The VarioModular pipes can be damaged by both atmospheric oxygen and UV rays and must not be stored outdoors.

At low temperatures ($\leq 5^\circ\text{C}$), the VarioModular pipe should be stored in heated rooms prior to processing.

VarioModular 11x1 pipe

The VarioModular pipe is completely integrated in the ModularPanel.

To prevent the integrated VarioModular pipes being damaged during the construction phase by drilling or breaking work, clearly-visible warning labels must be affixed at appropriate points. Download in Infocenter at www.variotherm.com.

In terms of weather resistance, the same instructions apply to the VarioModular 11x1 pipe as to the pre-insulated VarioModular 16x2 pipe.

ModularPanels

The ModularPanels are delivered on pallets. When storing, observe the load-bearing capacity of the storage location. The ModularPanels weigh 20 kg/m^2 and should always be stored flat on a level surface. If they are re-stacked during transport on the building site, the visible sides of the ModularPanels should be laid so that they face downwards.

They must be protected from moisture, especially rain. Panels that have become damp for a short time may only be handled after they have completely dried out.

Storing the panels vertically leads to deformation and damage to the edges. Transporting the panels horizontally within the building is possible using a pallet truck or other panel transport vehicle.

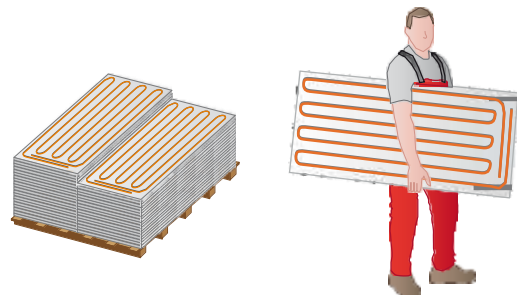

▲ It is best to carry individual ModularPanels vertically

2.6 Tools

Tools (on site) required/recommended for the installation work:

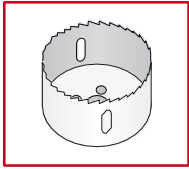

Hole saw

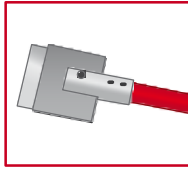

Adhesive scraper



Cartridge gun

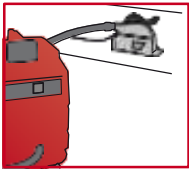

Circular saw or jigsaw

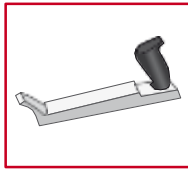

Plane for visible edges

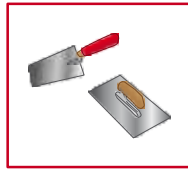

Trowel and plastering knife

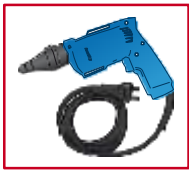

Power screw gun, preferable with latching depth stop



Clean buckets

Variotherm tools for connecting the Variotherm pipes:



Pipe cutting pliers

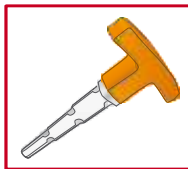

Calibration and chamfering tool

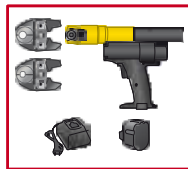

Pressing tool

2.7 Visible side/rear side of the ModularPanel

The visible side of the ModularPanel (the smooth side) faces into the room and the rear side (with the integrated Variomodular pipe) faces the substructure.

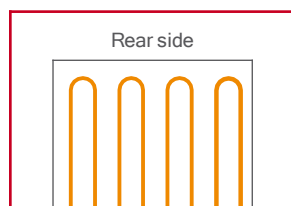
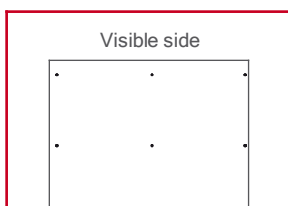

2.8 Humidity

During storage, assembly and further processing of the ModularPanels, as well as construction phase and use of the building, the relative humidity must not exceed 70%. Wet plaster and wet coats of paint must be put on and left to dry before the ModularPanels are installed. The ModularPanels may be installed in rooms up to humidity class W3 in accordance with ÖNB 3407 (or W1-I in accordance with DIN 18534-1).

2.9 Maximum flow temperature and dew point

Heating: The maximum flow temperature of the ModularPanels is 50 °C.

Cooling: The flow temperature must be selected in such a way or it must be ensured that the surface temperature of the ModularPanel (room-side and cavity) and the pipe never reaches or falls below the dew-point temperature at any point. Condensation can form on the pipes and surfaces if the flow temperature selected is too low. Control measures must be taken to prevent this (e.g. dew-point monitor, see Chapter 5.5).

2.10 Other work documents

Please also observe the latest FERMACELL planning and installation instructions! www.fermacell.com

3 SUBSTRUCTURE

1. General

Depending on the requirements, substructures are made of wood and/or metal, with or without surface planking, cavity insulation and vapour retarders (vapour barriers) ♦
Please observe the planning and installation guidelines of the manufacturer of the wooden or drywall system used for your wall and pitched roof ceiling construction ♦

- With wooden constructions, the timber used must be sufficiently dry and straight, and conform to the Austrian standard EN 338 (sorting class C24)
- With metal constructions, the profiles must be made of soft, non-alloyed steel with double-sided galvanising of at least 100 g/m² according to the ÖNORM DIN 18182-1
- Before installing the ModularPanels it must be ensured that the construction is designed to carry the weight of the ModularPanels (20 ♦ 5kg/m²) and any eventual cladding (tiles)
- Do not glue the ModularPanels directly to solid wall structures (plaster)

2. Vertical stud construction (standard variant)

Substructure with wooden or metal profiles, with or without insulation as required ♦ With larger existing stud clearances, extra vertical studs are used at the intended heating/cooling surfaces ♦ Stud spacing: 312 ♦ 5mm (panel thickness of 625 mm) or 300 mm (for panel thickness of 600 mm) ♦

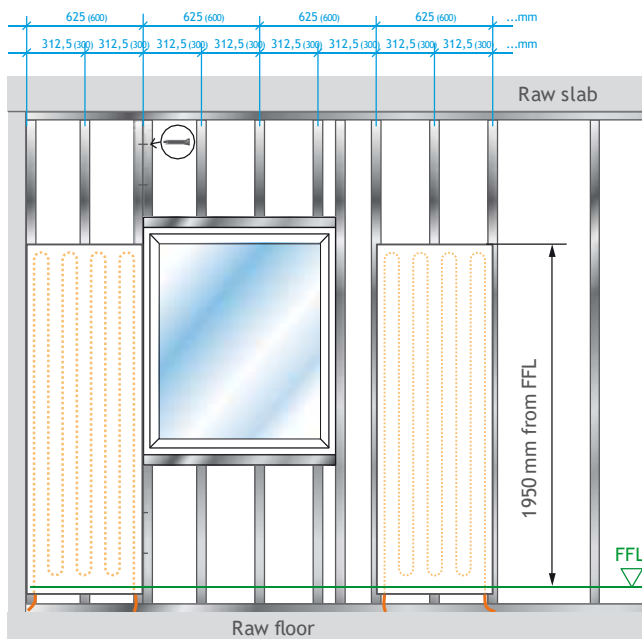

▲ Example of CW stud construction

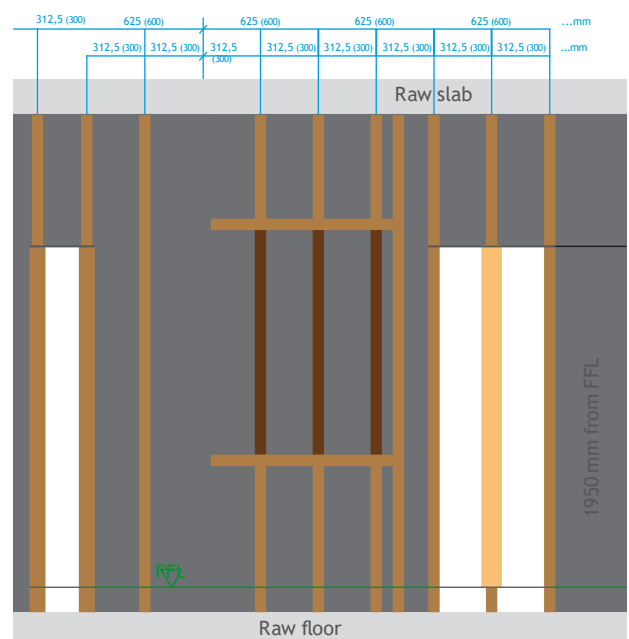

▲ Example of wooden stud construction

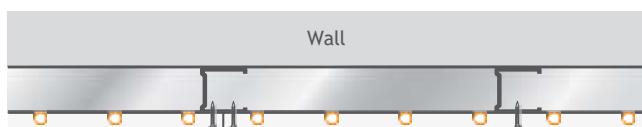

▲ Section through a CW/UW profile metal substructure, without cavity insulation ♦

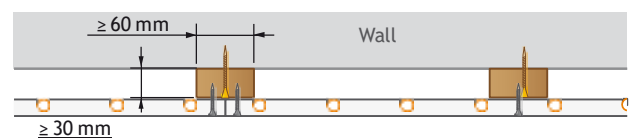

▲ Section through a softwood wooden substructure, without cavity insulation ♦

FFL ... Finished Floor Level

3.3 Full-surface FERMACELL planking

Under the following conditions, the ModularPanels can be screwed directly to the full-surface FERMACELL planking:

- › The substructure is fully planked with FERMACELL panels (minimum thickness 12.5 mm).
- › The stud clearance of the FERMACELL substructure corresponds to the values in the table:

Application area/ Construction type	Max. stud clearances of the substructure in mm for the following thicknesses of FERMACELL panels ¹		
	12.5 mm	15 mm	18 mm
Vertical surfaces (partition walls, wall cladding, single wall panels)	625 mm	750 mm	900 mm
Pitched roof ceiling cladding (10-50° pitch)	420 mm	500 mm	550 mm

¹ Limiting conditions:

In the case of fire protection requirements, the specifications of the test verification/certification should be observed.

Not possible in rooms where use results in constant high humidity (wet rooms etc.)

Caution:

- › Ensure a minimum seam offset of 200 mm to the FERMACELL planking.
- › Avoid cross joints.
- › With multi-layer Fermacell planking only the ModularPanels (last layer) are glued and stopped.

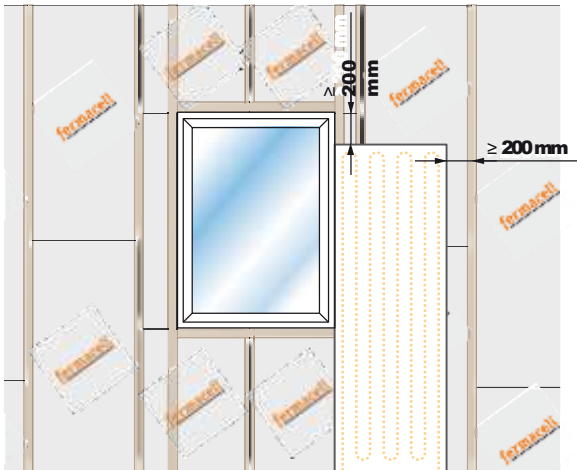

The ModularPanels are attached directly to the FERMACELL planking (minimum panel thickness of the first layer: 12.5 mm) with the following fasteners:

- ✦ Dry wall screw
 - › See table on page 18 for the number of screws
- ✦ Straddle staples
 - › Galvanised and treated with resin
 - › Wire diameter ≥ 1.5 mm
 - › Saddle width: ≥ 10 mm
 - › Leg length 2-3 mm shorter than the thickness of both panel layers (ModularPanel + FERMACELL panel)
 - › Distance between staples: max. 150 mm
 - › Distance between rows of staples: as fastening area

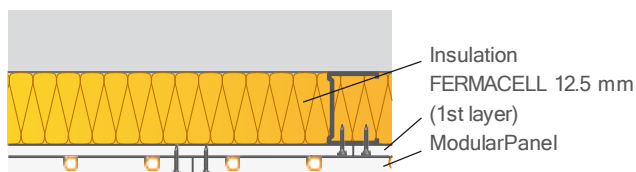

Section through a CW/UW profile **metal construction**, single-sided with **12.5 mm thick FERMACELL** panels, single-layer planking with cavity insulation and installed ModularPanel (**screwed**).

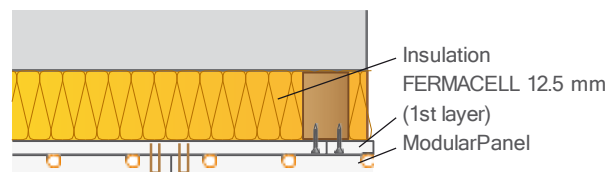

Section through a **softwood wooden construction**, single-sided with **12.5 mm thick FERMACELL** panels, single-layer planking with cavity insulation and installed ModularPanel (**clip fasteners**).

3.4 Full-surface plasterboard planking

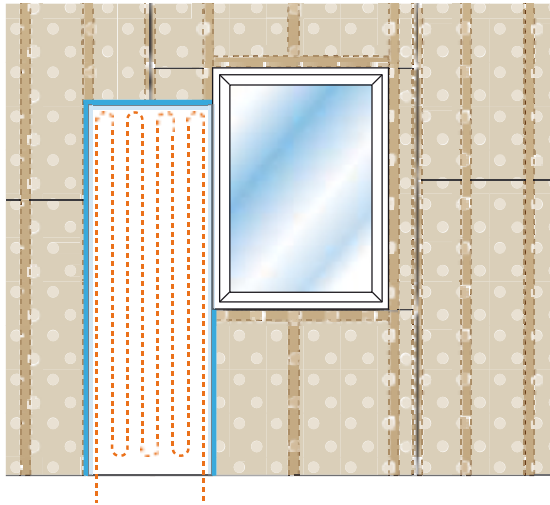

The lack of screw retention strength in the plasterboard panels means that the ModularPanels can only be directly fastened to the underlying stud construction with offset seams. A separating layer (adhesive tape) is always inserted in the glued seam area.

The stud clearance of the plasterboard stud construction must be as specified in section 3.2 (stud clearance of 312.5 mm).

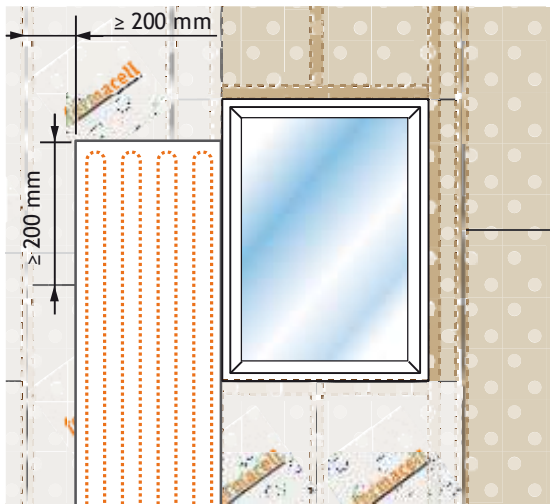
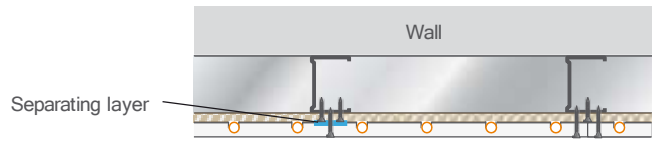

If the substructure can no longer be changed, appropriately thick FERMACELL panels (see table in chapter 3.3) are screwed to the stud construction behind the plasterboard planking.

The seams of the FERMACELL planking are not glued or stopped.

See section 3.3 on fastening the ModularPanels to the FERMACELL planking!

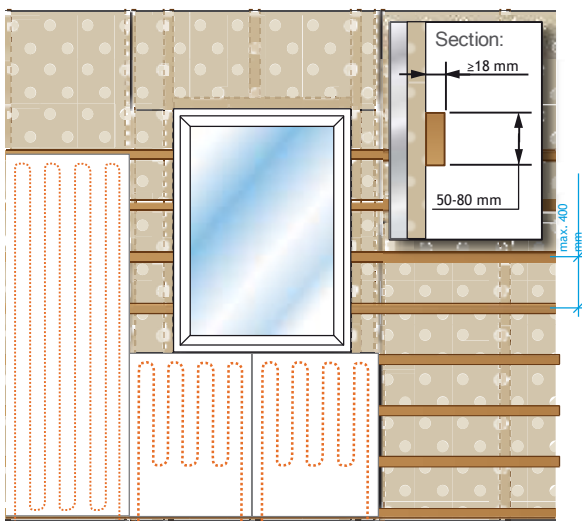
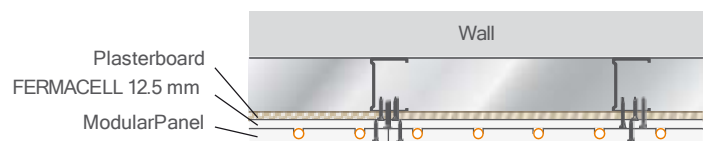

If the substructure is also unsuitable for full-surface FERMACELL planking, additional horizontal battens (recessed formwork) are screwed to the underlying stud construction instead.

See section 3.6 for information on installing the recessed formwork and fastening the ModularPanels!

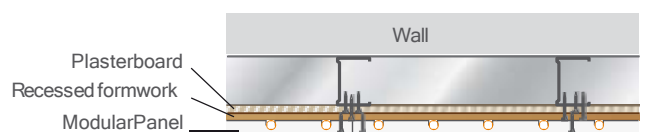

3.5 Full cladding or chipboard panel planking

Chipboard panels and ModularPanels (FERMACELL gypsum fibreboards) have different expansion and contraction behaviour under climatic fluctuations. The fastening variants described below can be recommended when the chipboard panels are not subjected to moisture loads. Caution:

- › Ensure a minimum seam offset of 200 mm to the planking.
- › Avoid cross joints.
- › A separating layer (adhesive tape) is always inserted into the glued seam area.

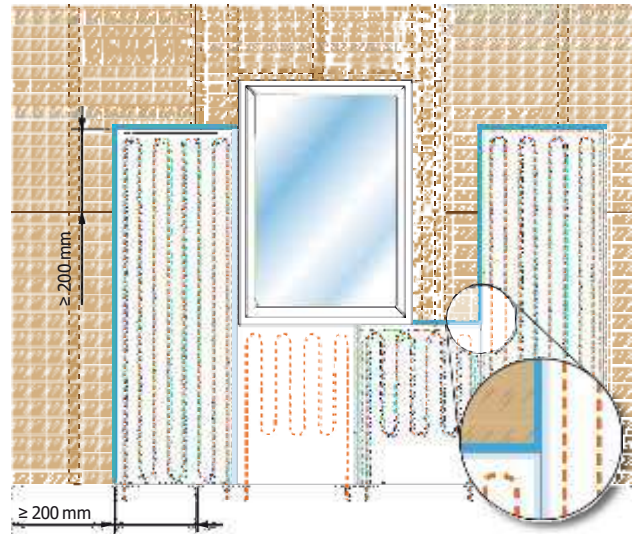
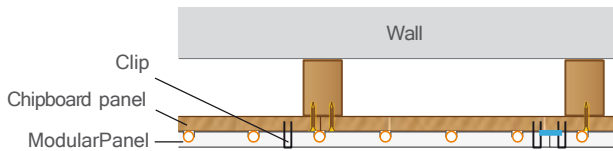

The ModularPanels are installed with the following straddle staples:

- › Galvanised and treated with resin
- › Wire diameter ≥ 1.5 mm
- › Saddle width: ≥ 10 mm
- › Leg length 2-3 mm shorter than the thickness of both panel layers
- › Distance between staples: max. 150 mm
- › Distance between rows of staples: as fastening area (see page 19)

The ModularPanels can alternatively be screwed to the planking (special case):

With chipboard panels having expansion and contraction values of max. 0.02 % (for changes to the material moisture of 1 % below the fibre saturation) the Modular Panels can also be screwed to the planking. According to DIN EN 1995 Table NA.7 this includes plywood, cross-laminated timber and OSB/4 panels. In this case it is important that the panels have adjusted to the relative humidity of the working climate. The humidity during installation, construction and used of the building must be 30-65 %.

3.6 Recessed formwork/horizontal battens

Extra recessed formwork is installed if the substructure does not have the correct batten clearance (300 or 312.5 mm). Horizontal wooden battens and ModularPanels have different expansion and contraction behaviour.

Batten guidelines (recessed formwork):

- › Height: 50-80 mm
- › Thickness: min. 18 mm
- › Stud clearance: max. 400 mm, see page 19

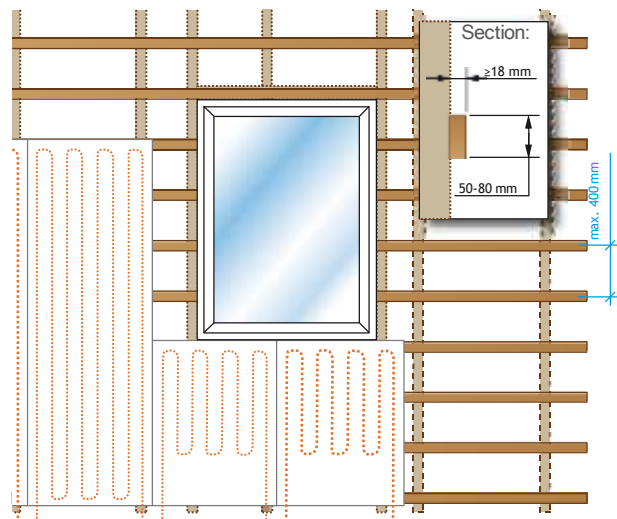
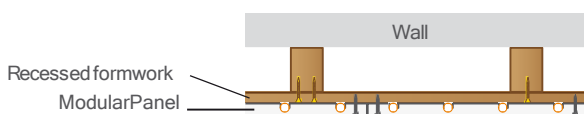

3.7 Pitched roof substructure

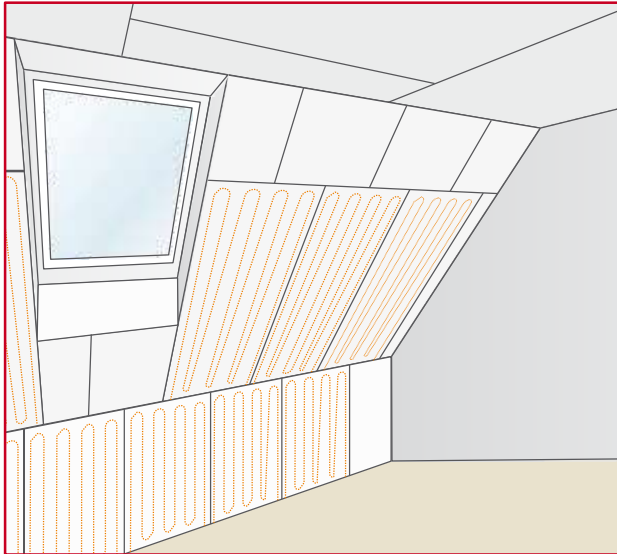

For a pitched roof, the same substructure possibilities apply as for walls.

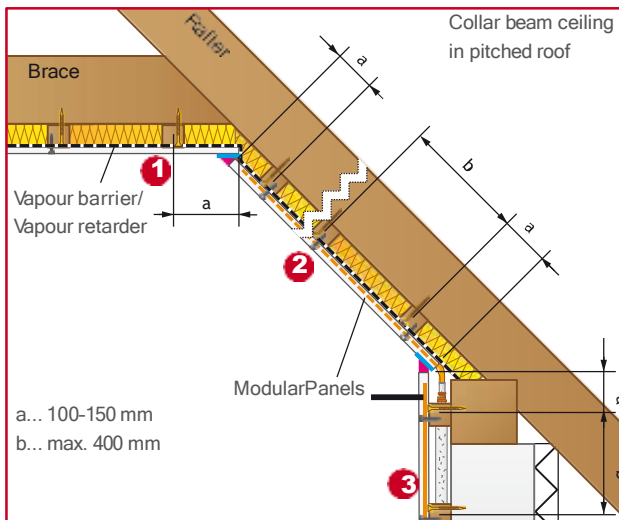

Cross-section - horizontal battens

Installation process:

- 1 Horizontal surfaces
- 2 Pitched surfaces
- 3 Vertical surfaces

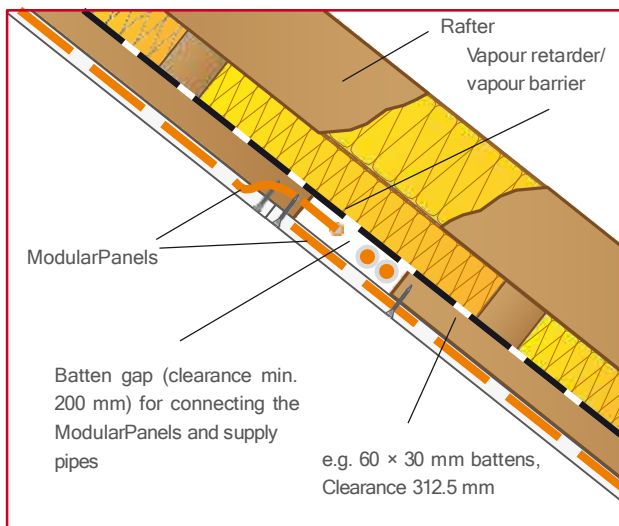

When two ModularPanels are abutted above each other in a pitched roof then additional vertical battens for the supply pipes are absolutely necessary!

3.8 Substructure variant for existing floors

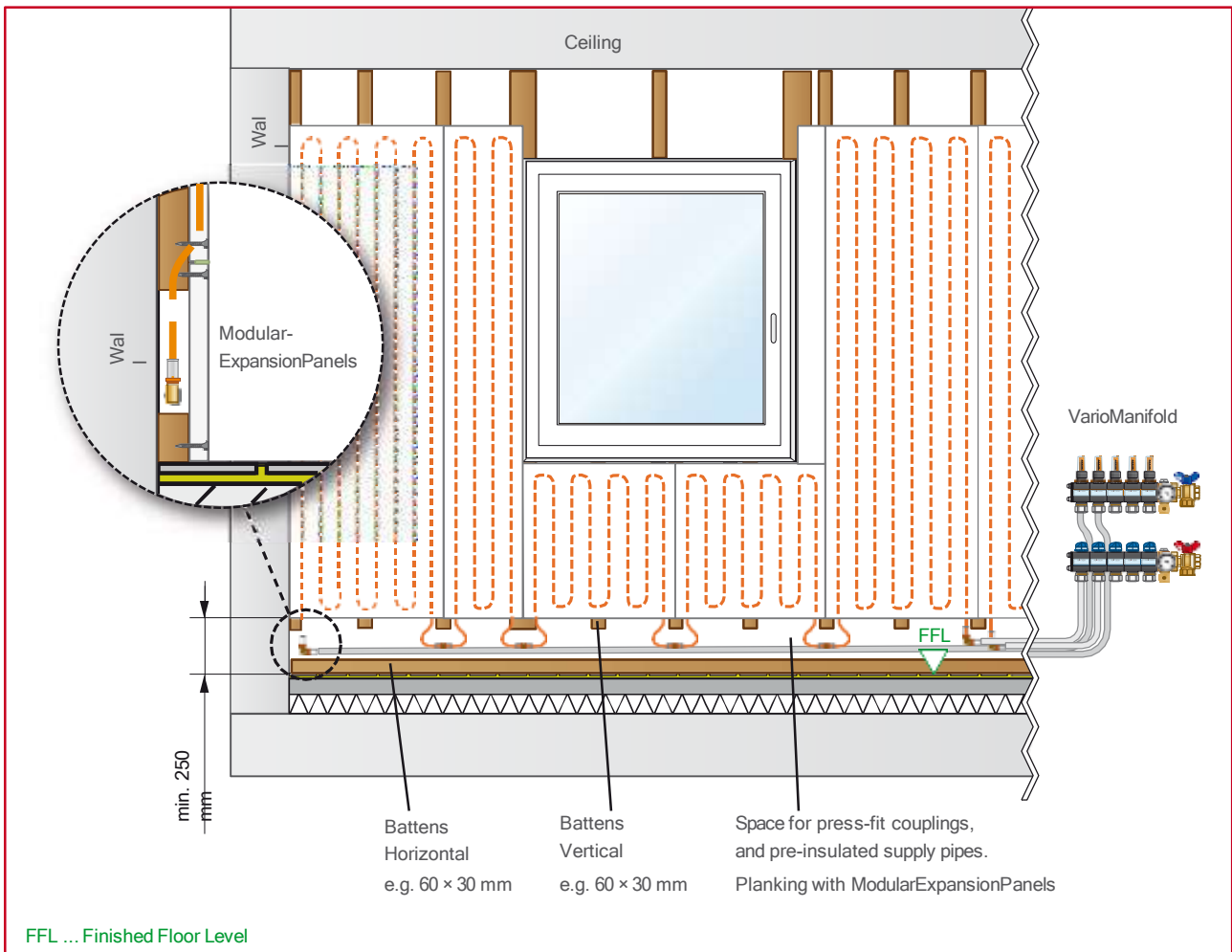

Variant as facing wall:

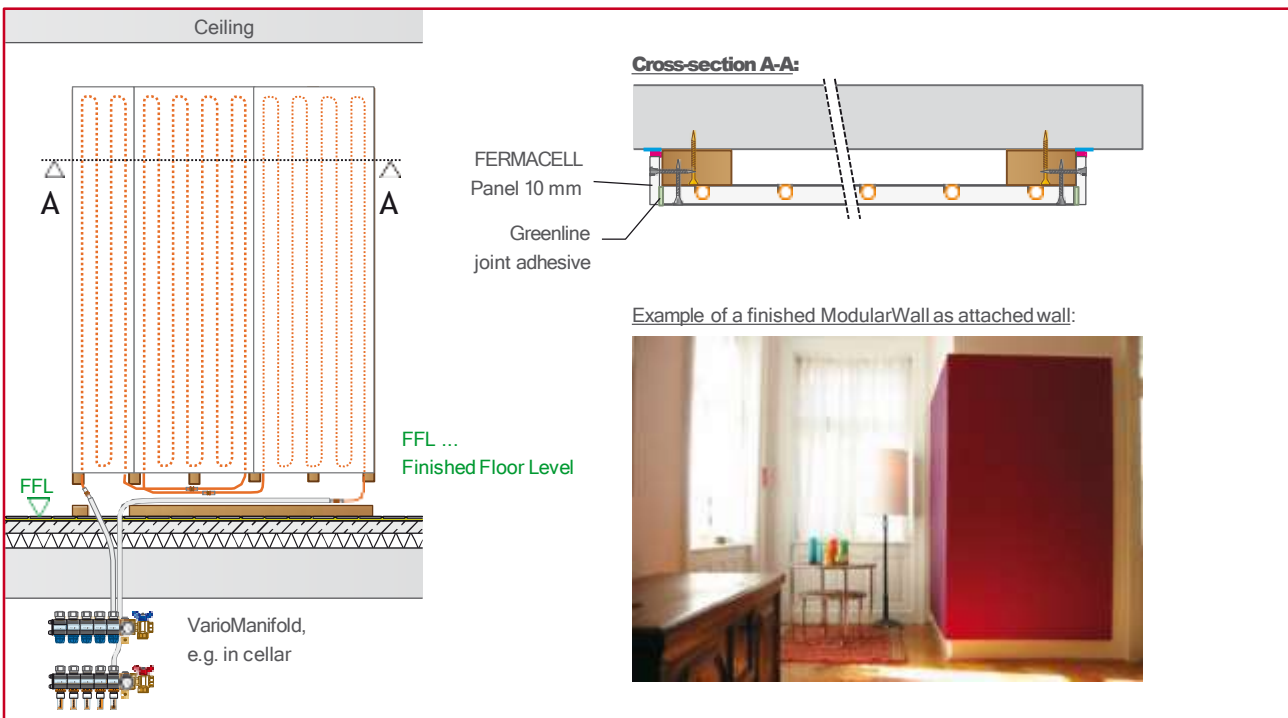

4 FIRE PROTECTION

The **Variotherm Modular Panels 18 mm with integrated VarioModular pipes** are equivalent to a **12.5 mm FERMACELL gypsum fibre board without pipes** (Test IBS-Linz No. VFA2001-0389.01, fire protection assessment file number 10111710). Please observe the relevant FERMACELL regulation and FERMACELL fire protection assessments.



IBS - INSTITUT FÜR BRANDSCHUTZTECHNIK UND SICHERHEITSFORSCHUNG
 GESellschaft M.B.H.

STÄDTLICH ANERKANNTES PRÜF- UND BEWERTUNGSINSTITUT FÜR GRUNDLAGENBESTIMMTE BRANNSCHUTZBEWERTUNGEN BEI BAUTEILEN UND BAUTEILANORDNUNGEN
 AN BAUTEILE, AN BAUTEILANORDNUNGEN UND AN BAUTEILEN UND BAUTEILANORDNUNGEN BEI BRANDSCHUTZBEWERTUNGEN
 AN BAUTEILE, AN BAUTEILANORDNUNGEN UND AN BAUTEILEN UND BAUTEILANORDNUNGEN BEI BRANDSCHUTZBEWERTUNGEN

Variotherm Heizsysteme GmbH
 Herr Ing. Thomas Baumgartner
 Gürteladorfer Strasse 3a
 A- 2544 Leobersdorf

Datum: 17. November 2010
 Aktennummer: 10111710
 Bearbeiter: Dipl.-Ing. (FH) U. Stockl / hase
 DRW 672

Brandschutztechnische Beurteilung, Aktennummer: 10111710
 Brandsversuche entsprechend EN 1364, Teil 1 sowie EN 1365, Teil 2 sowohl eines unbelasteten Wandelementes als auch eines tragenden Deckenelementes der Firma Variotherm Heizsysteme GmbH

Aufgrund der in der Prüfstelle IBS Linz durchgeführten Brandprüfungen wird bestätigt, dass sowohl ein unbelastetes Wandelement als auch ein tragendes Deckenelement der Firma Variotherm Heizsysteme GmbH die Prüfbedingungen entsprechend EN 1364, Teil 1 sowie EN 1365, Teil 2 erfüllen.

Die Variotherm Modulplatten bestehend aus einer 18 mm Fermacell-Platte mit eingelegeten Mehrschichtverbundrohr 11,6 x 1,6/Alu 0,20 mm wurden zwei Brandprüfungen unterzogen:

- 1.) Brandversuch einer nichttragenden Wand nach EN 1363-1 und EN 1364-1
 Prüfbericht Nr.: 10050617
 Prüfdatum: 31.08.2010
 Prüfdauer: 45 Minuten und 20 Sekunden
 Nach EN 13501-2 Kapitel 7.5.2 in die Feuerwiderstandsklasse EI 45 einzustufen
 Der Brandversuch vom 31.08.2010 am IBS Linz wurde dem Versuch mit der Prüfbericht Nr.: PG10934 vom 12.04.2002 am Danish Institute of Fire and Security Technology nachgestellt, bei dem eine Versuchszeit von 35 Minuten erreicht wurde.
- 2.) Brandversuch eines tragenden Deckenelementes nach EN 1363-1 und EN 1365-2
 Prüfbericht Nr.: 10050618
 Prüfdatum: 28.09.2010

VARIOTHERM
 HEIZSYSTEME GMBH

English Translation according to „Brandschutztechnische Beurteilung“:

Fire safety assessment, file number: 10111710

Fire tests in accordance with EN 1364, Part 1 as well as EN 1365, Part 2 on an unloaded wall element as well as on a load-bearing ceiling element of the company Variotherm Heizsysteme GmbH

On the basis of the fire tests carried out at the testing body IBS Linz, we hereby certify that both an unloaded wall element as well as a load-bearing ceiling element from the company Variotherm Heizsysteme GmbH satisfy the test requirements in accordance with EN 1364, Part 1 as well as EN 1365, Part 2.

The Variotherm modular panels, consisting of an 18 mm Fermacell panel with inserted multi-layer composite pipe 11.6 x 1.5/Alu 0.20 mm, were subjected to two fire tests:

- 1.) Fire test on a non-load-bearing wall as per EN 1363-1 and EN 1364-1 Test report no.: 10050617
 Test date: 31/08/2010
 Test duration: 45 minutes and 20 seconds
 In accordance with EN 13501-2 Section 7.5.2 to be classified under the fire resistance category **EI 45**
 The fire test dated 31/08/2010 at the IBS Linz was a reconstruction of the trial as per test report no.: PG10934 dated 12/04/2002 at the Danish Institute of Fire and Security Technology in which a trial duration of 35 minutes was achieved.
- 2.) Fire test on a load-bearing ceiling element as per EN 1363-1 and EN 1365-2
 Test report no.: 10050618
 Test date: 28/09/2010
 Test duration: 100 minutes and 20 seconds
 In accordance with EN 13501-2 Section 7.3.3 to be classified under the fire resistance category **REI 90**
 The fire test dated 28/09/2010 at the IBS Linz was a reconstruction of the trial as per test report no.: MA39-VFA 2002-2173.01 dated 14/04/2003 at the Municipal Department 39 of the Research and Testing Institute of the City of Vienna in which a trial duration of 94 minutes was achieved.

Fire safety assessment

The fire tests carried out at the IBS were identical in terms of their structure to the fire tests carried out at the above mentioned testing institutes, with the difference that the 12.5 mm thick Fermacell panels facing the fire were replaced by 18 mm thick Variotherm modular panels.

On the basis of the test results available as per ÖNORM EN 1364, Part 1 as well as ÖNORM EN 1365, Part 2, it can be ascertained that at least identical results were achieved with the 18 mm thick Variotherm modular panels as with the 12.5 mm thick Fermacell panels, meaning that there is direct comparability.

It can therefore be confirmed that, in lightweight constructions (walls, ceilings, pitched roofs), the normal 12.5 mm thick Fermacell panels can be replaced by 18 mm thick Variotherm modular panels without disadvantages in terms of the fire resistance.

IBS - INSTITUT FÜR BRANDSCHUTZTECHNIK UND SICHERHEITSFORSCHUNG GESELLSCHAFT M.B.H.
 Accredited testing and inspection body

Examples of fire protection fittings

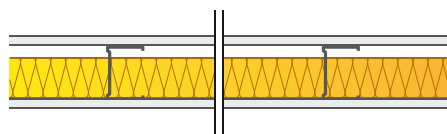

wall structure with 12.5 mm Fermacell gypsum fibreboards



with Variotherm ModularPanel

Fire resistance as per ÖN EN 13501-2: **EI 60***

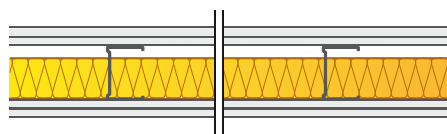

wall structure with 12.5 mm Fermacell gypsum fibreboards

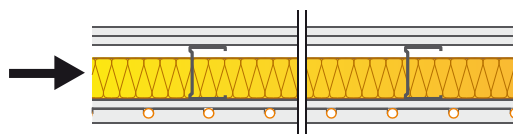

with Variotherm ModularPanel

Fire resistance as per ÖN EN 13501-2: **EI 90***

* For details regarding wall fittings, please refer to the Fermacell planning documents.

5 COMPONENTS

5.1 ModularPanels / ModularExpansionPanels - Overview

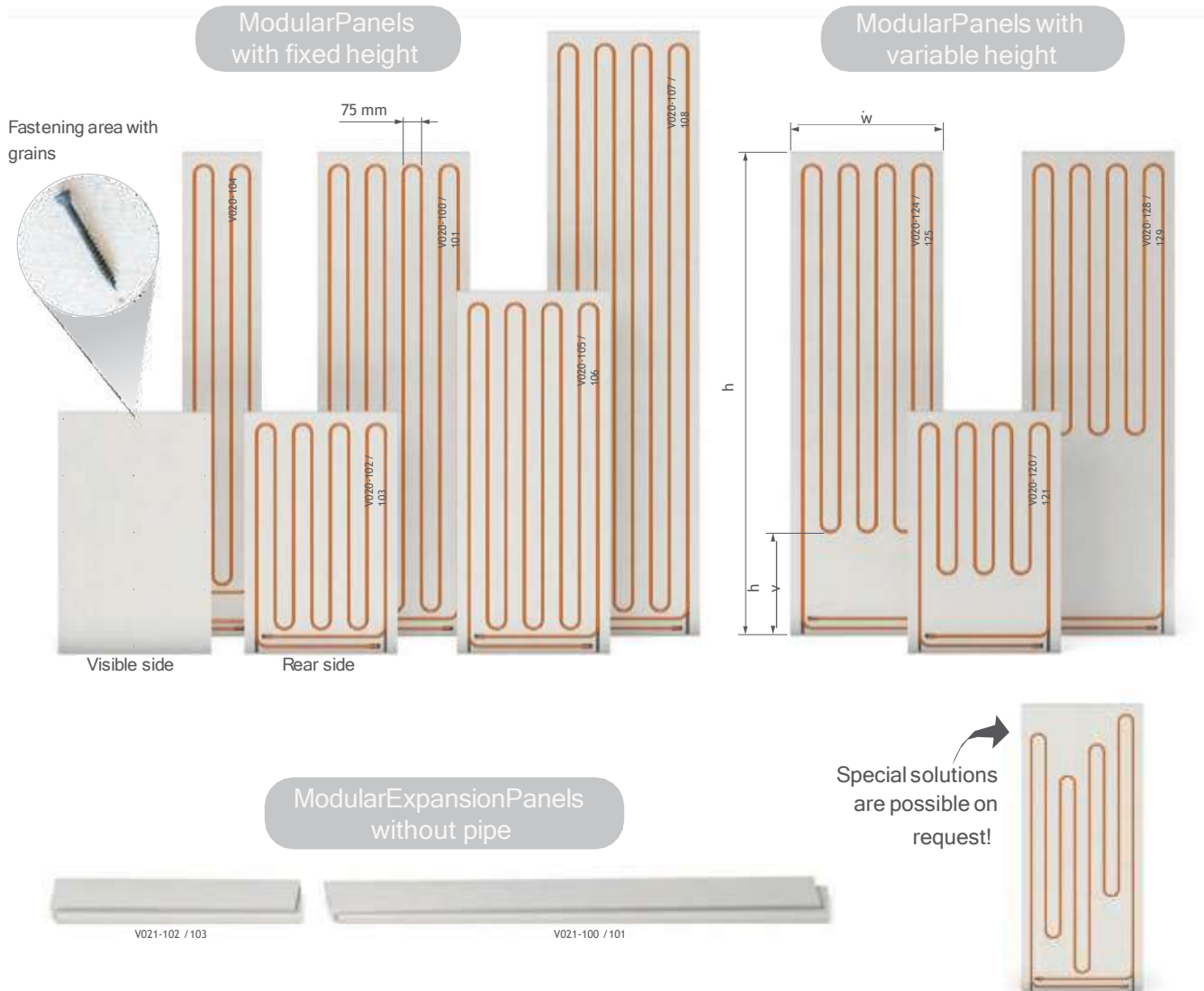

The ModularPanels are 18 mm thick, environmentally safe-tested gypsum fibreboards. The VarioModular 11.6x1.5 pipes are already integrated in the back of the panels. The axis clearance of the pipes is 75 or 105 mm

Panels with either fixed or variable height are available:
Fixed height: The entire surface of the ModularPanel is laid with pipes and serves as a heating/cooling surface.
Variable height: Only part of the panel is laid with pipes and serves as a heating/cooling surface, the unused area (hv) can be cut to size individually or, for example, be used as a recess for sockets.

Panel technical data:

Panel: Building biology tested gypsum fibre board
Fire resistance as per EN 13501-1:
 non-flammable, A2
Identification as per EN 15283-2:
 GF-I-W2-C1
Thermal conductivity λ : 0.32 W/mK
Apparent density ρ_k : 1150 \pm 50 kg/m³
Water vapour diffusion resistance factor μ : 13



Overview of the ModularPanels/ModularExpansionPanels

ModularPanels

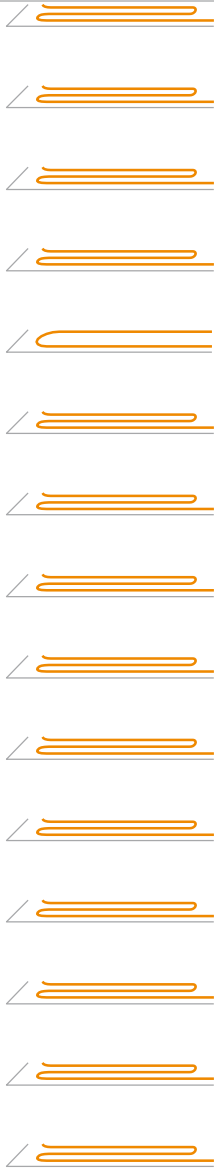

ModularExpansionPanels

V021-100		-	2000 × 625	-	1.25	without pipe	27.1 kg	3 × 9 pcs.	6 × 5 pcs.
	MAC-2000-625								
V021-101		-	2000 × 600	-	1.20	without pipe	26.0 kg	3 × 9 pcs.	6 × 5 pcs.
	MAC-2000-600								
V021-102		-	1000 × 625	-	0.63	without pipe	13.6 kg	3 × 5 pcs.	4 × 5 pcs.
	MAC-1000-625								
V021-103		-	1000 × 600	-	0.60	without pipe	13.0 kg	3 × 5 pcs.	4 × 5 pcs.
	MAC-1000-600								

¹ Apart from the quantity, in the case of fire protection requirements test verification/certification may result in different specifications!
Spread out bolts evenly across the length/width of the panel.

Fastening area of the Modular Panels - battens length

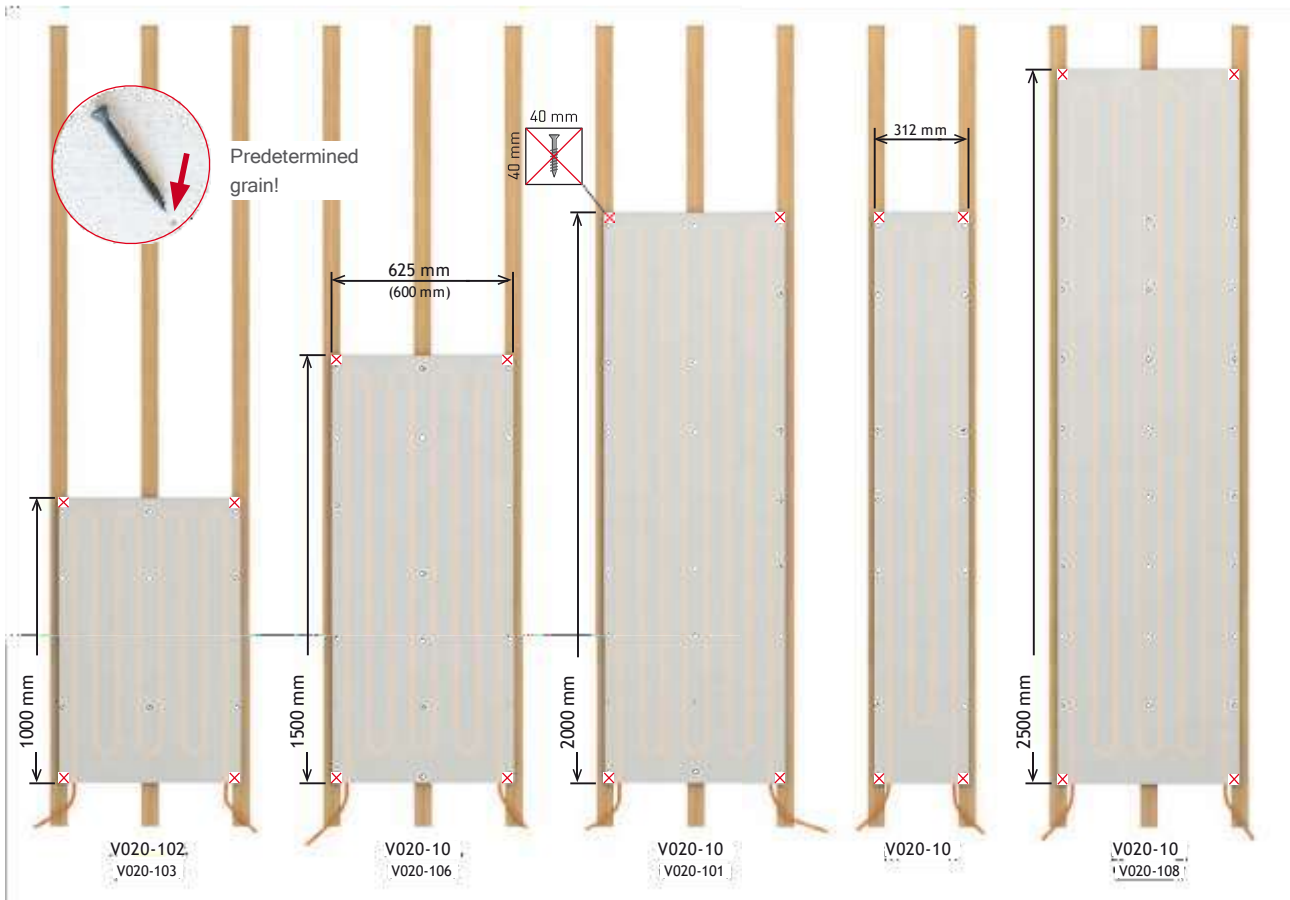

Fastening area of the Modular Panels - battens across

Spacing of the battens depends on the panel height.
Predetermined grain CANNOT be used.

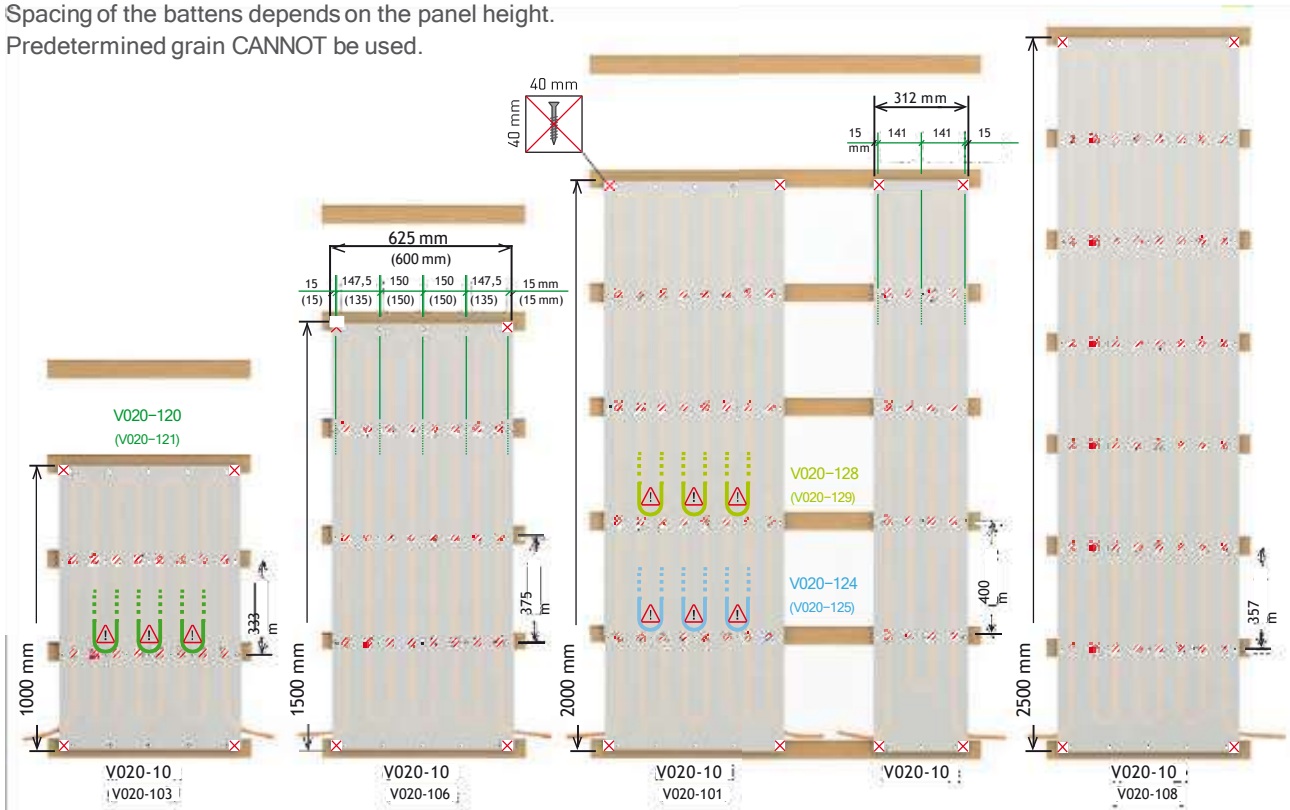

5.2 ModularPanels / ModularExpansionPanels - Installation

- > Dry wall screws 3.9 x 40 mm
- > Part No.:
F120-0250 (PKU: 250 pcs.)
F120-1000 (PKU: 1000 pcs.)
- > Weight:
0.6 kg (F120-0250)
2.4 kg (F120-1000)
- > Consumption: 16 pcs./m²
- > Optimum shank length
- > Incl. associated bit



- > Greenline joint adhesive
- > Part No.: F111
- > PKU: 1 cartridge
- Carton with 25 cartridges
- > Weight/PKU: 550 g
- > Consumption: ~7 m² / cartridge
- > For connecting the blunt adjoining ModularPanels

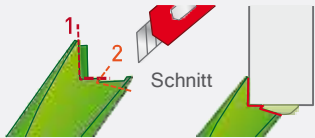

A tip from Variotherm: Cut off the cartridge tip as shown in the illustration.

- > Adhesive tape
- > Part No.: V288
- > Weight: 210 g
- PKU: 1 pce.
- Carton with 36 pcs.
- > As a separating layer to joint surfaces or between the panel contact points and the substructure (if required)

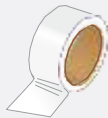

A tip from Variotherm: Use a power screw gun if possible and set the penetration depth of the screw head to approx. 0.1 mm.

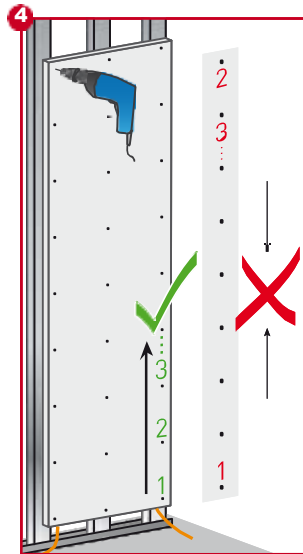
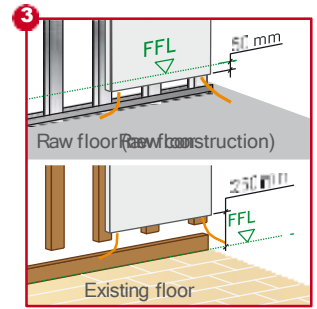
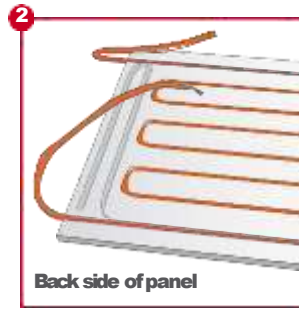
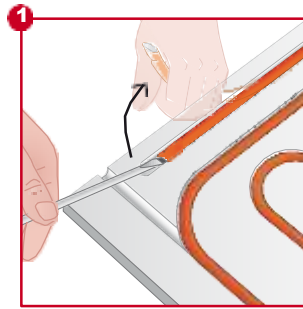

The ModularPanel is installed in the fastening area (see page 19) using dry wall screws 3.9 x 40 mm or staples.

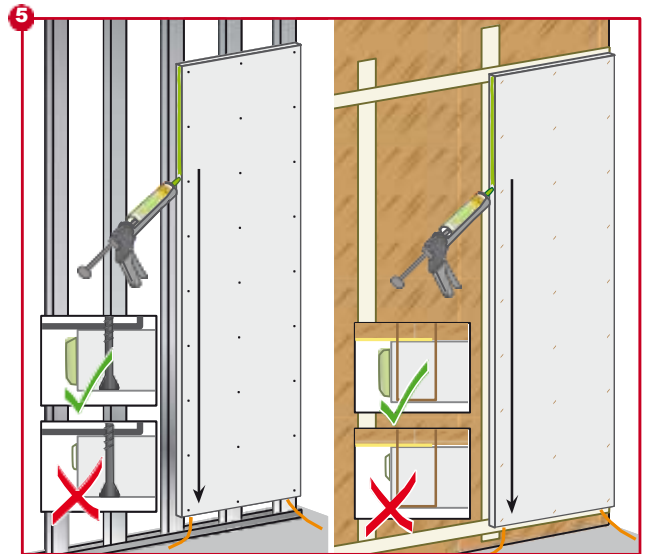

Apply Greenline joint adhesive in flat bulge shapes (width around 14mm) to the well-dusted panel edge. Processing temperature: Glue > 10 °C, room temperature > 5 °C. For solid formwork or wood-based panels as a sub-surface: adhesive tape is necessary in the area of the adhesive seams!

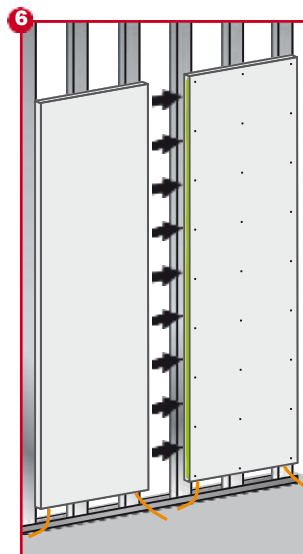

Press the second ModularPanel against the first so that the seam becomes tight. The seam width must not exceed 1 mm. Leave the seam adhesive approx. 18 to 36 hours to harden and only afterwards scrape off excess (see also Chap. 6.1).

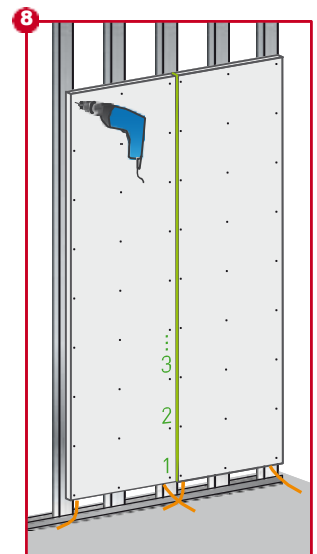
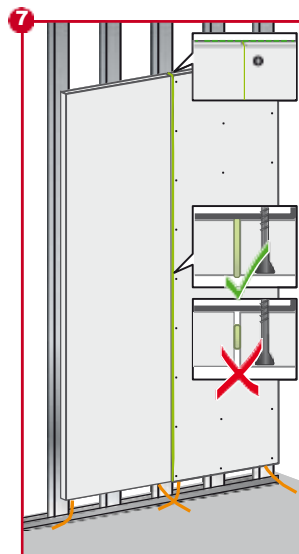

Screw the second ModularPanel in the correct order and repeat with each additional ModularPanel.

Adapt ModularPanels

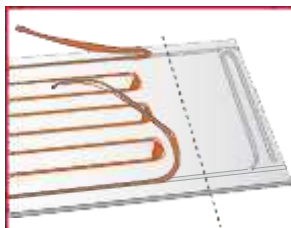

▲ Shorten the variable ModularPanels in length

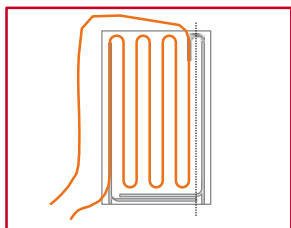

▲ Shorten the Modular-Panels in width

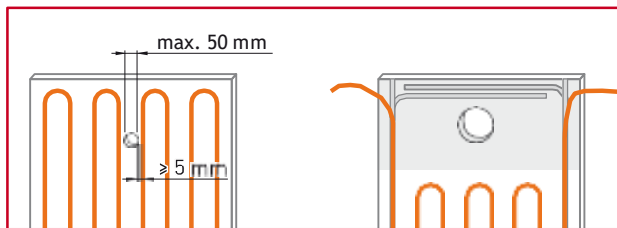

▲ Cut-out for blank piping, sockets, etc.

ModularExpansionPanels

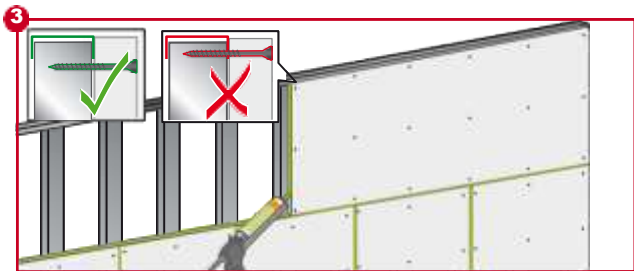
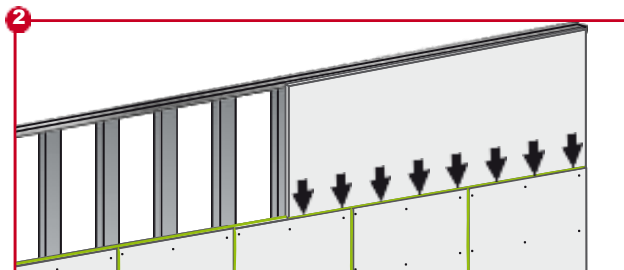
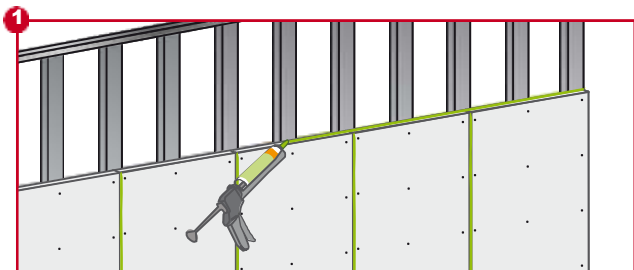

The remaining surfaces to the side of or above the ModularPanels are filled with ModularExpansionPanels with offset seams. The assembly is 1:1, as with the ModularPanels.

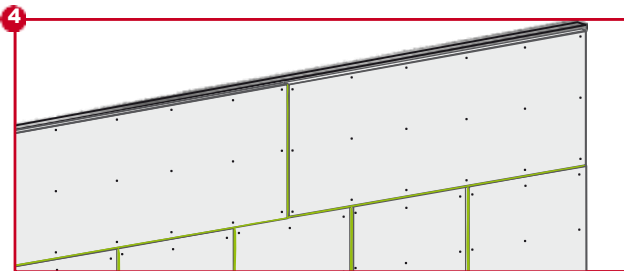

For cut board edges (handheld circular saw), it should be noted that cut edges are to be dusted directly and immediately before the application of the joint adhesive. Cross joints should be avoided.

Transitions to other panel materials

Different materials expand in different ways. Therefore, a wall surface should be installed with the same panel material throughout.

Variotherm provides no warranty for transitions to other board materials (for example gypsum plasterboards). Please observe the guidelines of the respective (panel) manufacturers.

As a possibility for transitions, we can provide the following examples from practice:

- > Grouted joints (approx. 7 mm) with a separating layer (= decoupled connection). Advantage: intentional straight crack (usually hardly visible)
- > Elastic seams (acrylic mass) (maintenance seam, not permitted for fire-resistant constructions)
- > Fascia
- > Wooden strip fixed on one side for covering the transition

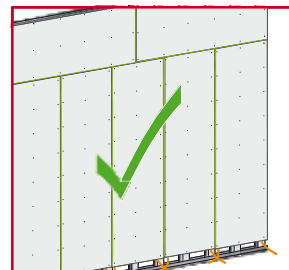

▲ Gypsum fibreboards

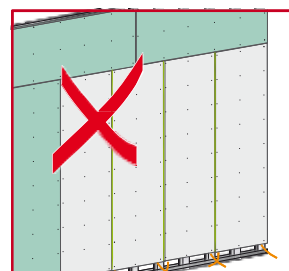

▲ Gypsum fibreboards and gypsum plasterboards

- > Duo Adhesive
- > Part No. F115
- > PKU: 1 Cartridge
- Carton with 10 cartridges
- > Weight/PKU: 1 kg
- > Consumption: ~7 m joint (4 mm width, 18 mm depth)
- > Special manual applicator W048 required!



- > Static mixing tube
- > Part No. F116
- > PKU: 1 pce
- Carton with 75 pcs
- > Weight/PKU: 15 g
- > Consumption: ~3 pcs/cartridge



- > Duo manual applicator
- > Part No. W048
- > PKU: 1 pce
- Weight/PKU: 1 kg
- > The matching manual applicator for applying the Duo adhesive



Installation of panels between installed ModularPanels

If "drop to drop" installation of the ModularPanels is not possible, proceed as follows:

- 1 Glue one side of the ModularExpansionPanel using greenline joint adhesive
- 2 Leave a 3 to 8 mm gap on the other side
- 3 Completely fill the gap with **Variotherm Duo adhesive (special manual applicator W048 required!)**

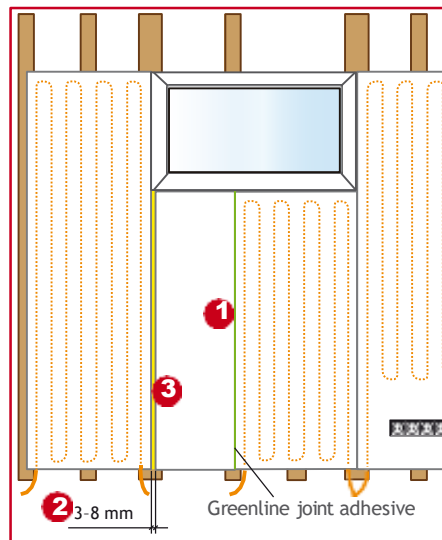
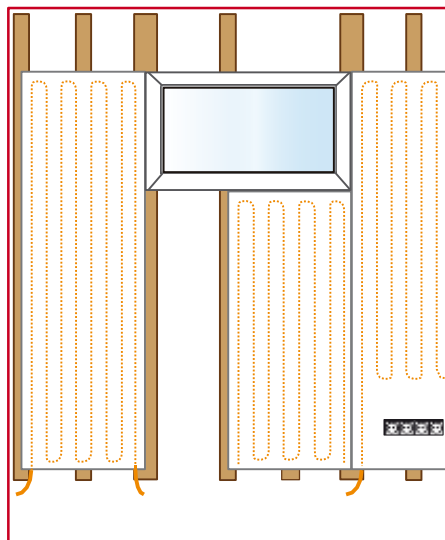

Processing the Duo Adhesive:

- > The surfaces of the ModularPanels must be clean, dry, dust-free and grease-free
- > Open the cartridge - screw on the static mixing tube
- > Insert the cartridge into the Duo manual applicator
- > For safety reasons, do not use the first amount of mixed adhesive for gluing (20 g, approx. walnut-sized)
- > Completely fill the joint from the top to the bottom using the static mixing tube
- > For a better filling result, use a pointing trowel (or similar) to slightly hollow out the fresh joint
- > Remove excess adhesive when still fresh. Hardened adhesive can only be removed with great effort
- > The static mixing tube remains on the cartridge unit at the end of work/during breaks - the static mixing tube is then replaced the next time work begins again
- > The joint can be covered with filler 4 hours after gluing the panels (working temperature > +15 °C)

Safety information for Duo Adhesive:

Keep out of the reach of children! For further information see the product label or the safety data sheets according to Regulation 1907/2006/EC, Annex II, available at www.variotherm.com/en/service/info-centre/safety-data-sheets.html

Wear suitable protective gloves. Protect your skin, eyes, clothing and tools from coming into contact with unhardened Duo adhesive. In the case of skin contact clean immediately with soap and water. Clean contaminated tools immediately with universal thinner. Hardened adhesive can only be removed mechanically.

Technical data for Duo Adhesive:

Basis: 2-component PUR reaction adhesive

Colour when hard: beige

Viscosity at +20 °C: low-viscosity paste

Working time (at +10/+20/+30 °C): approx. 60/30/15 minutes

Hardening time (+20 °C, 50% relative humidity): approx. 24 hours, final hardness after approx. 7 days

Working temperature: minimum of +7 °C to a maximum of +30 °C

Net weight: 900 g (2 x 310 ml tandem cartridge)

Consumption: 1 cartridge is sufficient for an approx. 7 m joint (4 mm width and 18 mm depth)

Storage: unopened, in a dry place at +15 °C to +25 °C approx. 15 months

Panel transitions

Inner and outer corners and T-joints are to be constructed as grouted joints (approx. 7 mm) ■ with a separating layer ■ (decoupled connection):

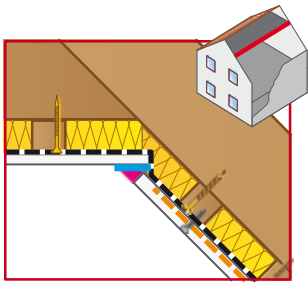

▲ Pitched roof to ceiling

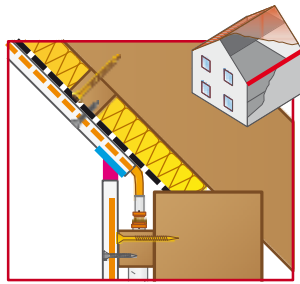

▲ Pitched roof to jamb wall

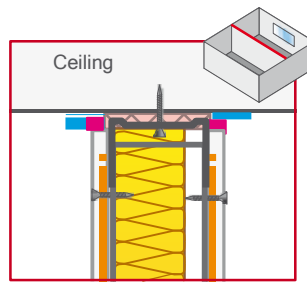

▲ Ceiling connection

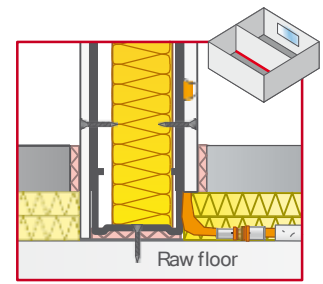

▲ Floor connection

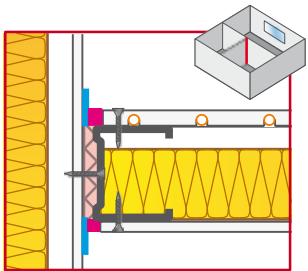

▲ T-connection, single-layer planking

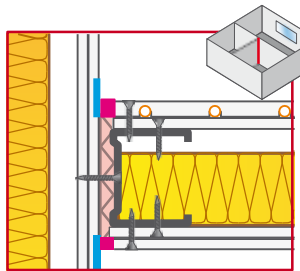

▲ T-connection, double-layer planking

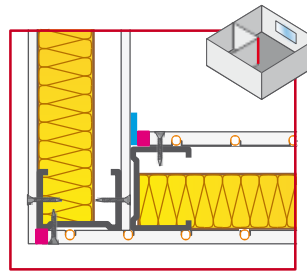

▲ Corner joints, single-layer planking

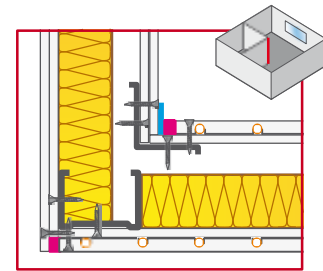

▲ Corner joints, double-layer planking

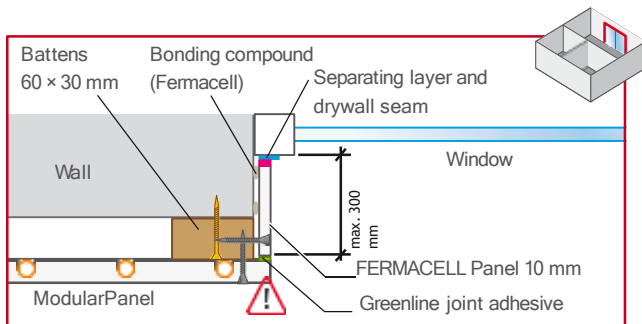

▲ Reveal area

⚠ Caution: Pay special attention to the Variomodular pipes when fastening the ModularPanels in the reveal area. (Fastening outside of the fastening area!)

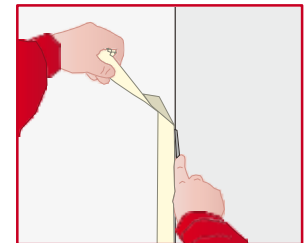

▲ Remove the excess separating layer (adhesive tape ■) at inner corners after filling!

Movement joints

Movement joints are to be provided every 8 m in wall constructions and pitched roofs.

⚠ Caution: Pay special attention to the Variomodular Pipes when fastening the ModularPanels in the area of the movement joints!

A ≤ 20 mm (Movement dimension), B ≥ 20 mm.

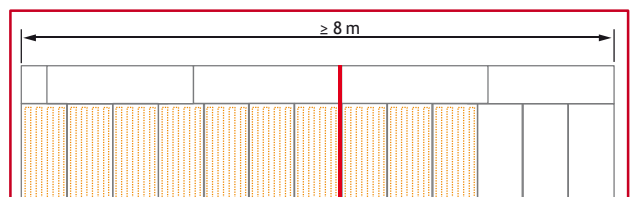

▲ Movement joint at e.g. 10×V020-100 and 3× V021-100 (13 × 0.625 m = 8.13 m)

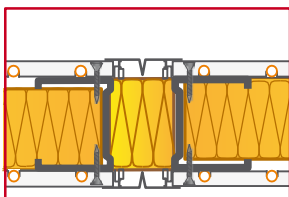

▲ Movement joint with additional profile

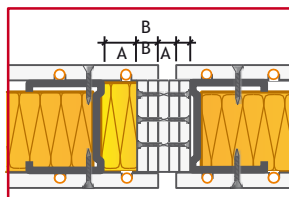

▲ Movement joint with panel strip

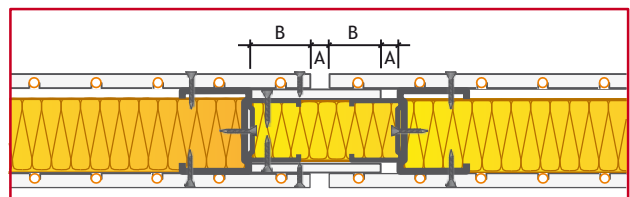

▲ Movement joint with strip bundle



- > Pre-insulated 16x2 VarioModular pipe
- > Part No.: V1226 (6 mm Insulation) V1227 (9 mm Insulation)
- > PKU: Roll with 100 m
- > Weight/PKU: 14.0 kg (6 mm Insulation) 14.9 kg (9 mm Insulation)
- > Insulation: Polyethylene soft foam
Fire resistance as per EN 14313: CL-s1,d0

- > Retaining clamp ø35
- > Part No.: V2802
- > PKU: 50 pcs.
- > Weight/PKU: 1 kg
- > for affixing the pre-insulated VarioModular pipes 16x2



- > Retaining clamp ø35
- > Part No.: V2803
- > PKU: 25 pcs.
- > Weight/PKU: 1 kg
- > for affixing the pre-insulated VarioModular pipes 16x2



5.3 VarioModular pipes

- 1 Temperature-resistance polyethylene (PE)
- 2 Adhesive layer
- 3 Homogeneous and solid aluminium pipe
- 4 Adhesive layer
- 5 Raised-temperature-resistance polyethylene (PE-RT)

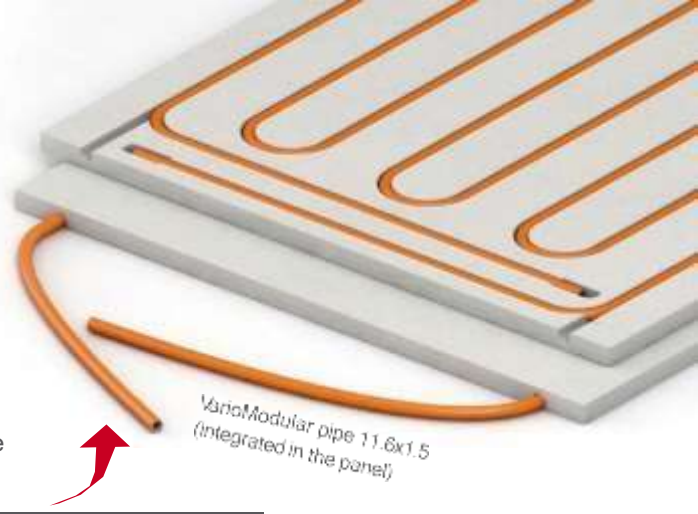

Technical data	11.6x1.5	(pre-insulated) 16x2
Pipe diameter	11.6 mm	16.0 mm
Pipe wall thickness	1.5 mm	2.0 mm
Aluminium pipe thickness	0.15 mm	0.18 mm
Water content	0.058 l/m	0.113 l/m
Special narrow bending radius (use a suitable bending device)	30 mm	40 mm
Max. operating temperature [t _{max}]	70 °C	70 °C
Short-term resistant [t _{ma}]	95 °C	95 °C
Max. operating pressure [p _{max}]	6 bar	6 bar
Linear expansion coefficient	2.3 × 10 ⁻⁵ [K ⁻¹]	2.3 × 10 ⁻⁵ [K ⁻¹]
Mean heat conduction coefficient [λ]	0.44 W/mK	0.45* W/mK
Heat transmission resistance	0.0034 m ² K/W	0.0045* m ² K/W



Pre-insulated VarioModular pipe 16x2 (supply pipe), Insulation thickness 6 or 9 mm

<< * Values without insulation

Advantages

- > Fully corrosion-free
- > Optimum creep behaviour
- > Just as light as a plastic pipe
- > 10-year guarantee with certificate
- > Flexible, easy to bend, extremely stable for m
- > Resistant to hot water additives (inhibitors, antifreeze)
- > Mirror-smooth inner surface - less pressure loss - no encrustation
- > High pressure and temperature resistance
- > 100 % oxygen diffusion-tight
- > Low linear coefficient of expansion, low heat expansion forces
- > Tested as per EN 21003

Creep behaviour

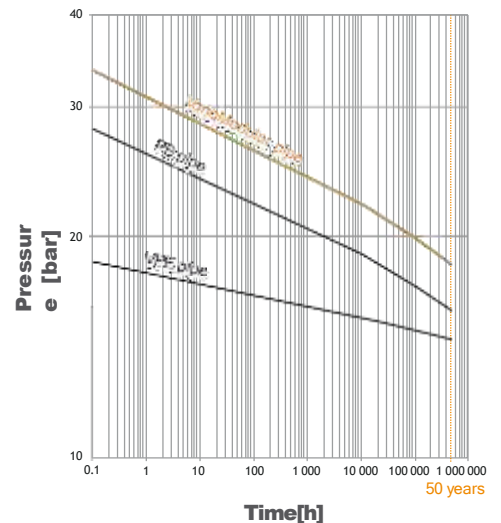

Elongation

with 10 m and temperature difference Δt 25 °C (e.g. 20 °C to 45 °C)

	Tubing	Elongation	
Plasti CS	PEX (VPE)	50.00 mm	
	PP	42.50 mm	
	PB	32.50 mm	
	PVC	20.00 mm	
Met a I	VarioModular pipe	5.75 mm	The VarioModular pipe combines the minor elongation and thermal expansion. So it is perfect for surface cooling/heating pipes.
	Cu	4.20 mm	
	Stainless steel	3.50 mm	
	Steel	2.88 mm	

5.4 Press-fit couplings / press tools

Connection options

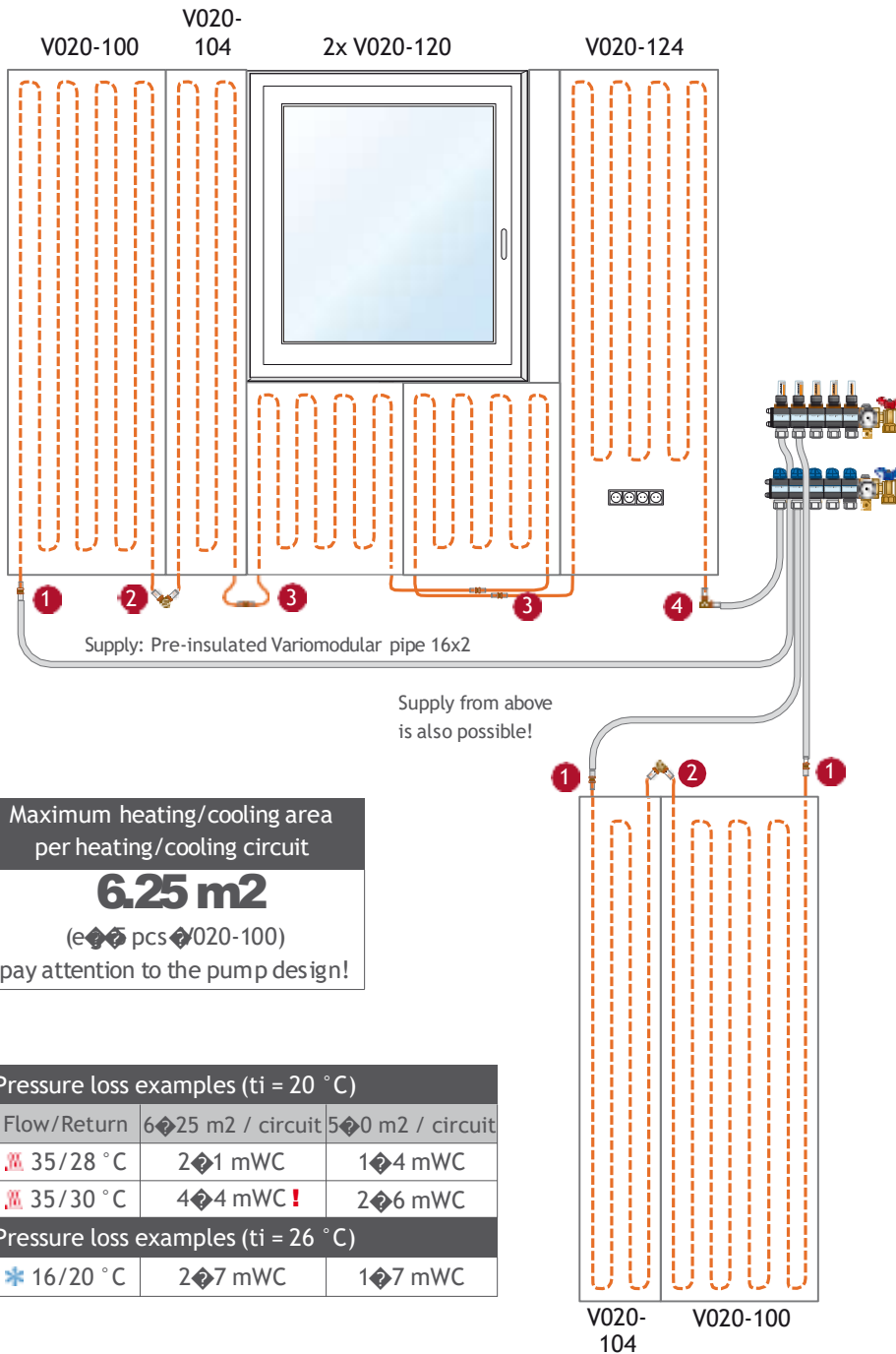

- > Press-fit coupling 16x11 \diamond 6
- > Part No \diamond Z1610
- > PKU: 1 pce \diamond
- > Weight/PKU: 45 g
- > Press contour: TH11 \diamond & TH16



- > Press-fit elbow 90° 11 \diamond 6x11 \diamond 6
- > Part No \diamond Z1630
- > PKU: 1 pce \diamond
- > Weight/PKU: 45 g
- > Press contour: TH11 \diamond

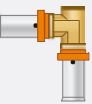

- > Press-fit coupling 11 \diamond 6x11 \diamond 6
- > Part No \diamond Z1600
- > PKU: 1 pce \diamond
- > Weight/PKU: 30 g
- > Press contour: TH11 \diamond



- > Press-fit elbow 90° 16x11 \diamond 6
- > Part No \diamond Z1620
- > PKU: 1 pce \diamond
- > Weight/PKU: 45 g
- > Press contour: TH11 \diamond / TH16

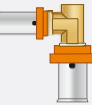

Maximum heating/cooling area per heating/cooling circuit

6.25 m²

(e \diamond pcs \diamond 020-100)

pay attention to the pump design!

Pressure loss examples (ti = 20 °C)

Flow/Return	6 \diamond 25 m ² / circuit	5 \diamond 0 m ² / circuit
Δ 35/28 °C	2 \diamond 1 mWC	1 \diamond 4 mWC
Δ 35/30 °C	4 \diamond 4 mWC !	2 \diamond 6 mWC

Pressure loss examples (ti = 26 °C)

* 16/20 °C	2 \diamond 7 mWC	1 \diamond 7 mWC
------------	--------------------	--------------------

- > Calibration and chamfering tool
- > Part No.: W042
- > PKU: 1 pce.
- > Weight/PKU: 140 g
- > For calibrating and chamfering the Variotherm pipes

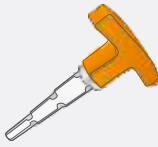

- > Pipe cutting pliers
- > Part No.: W037
- > PKU: 1 pce.
- > Weight/PKU: 230 g
- > For trimming the Variotherm pipes
- > Replacement blade: W0371



- > AkkuPress Mini
- > Part No.: W019
- > PKU: 1 pce.
- > Weight/PKU: 9.9 kg
- > Incl. sheet steel box, press-fitting jaws TH16 Mini & TH11.6 Mini, battery charger, 2 batteries



- > Mini press-fitting jaw TH11.6
- > Part No.: W031
- > PKU: 1 pce.
- > Weight/PKU: 1,5 kg



- > Mini press-fitting jaw TH16
- > Part No.: W032
- > PKU: 1 pce.
- > Weight/PKU: 1.6 kg



- > EcoPress
- > Part No.: W015
- > PKU: 1 pce.
- > Weight/PKU: 9.7 kg
- > Incl. sheet steel box, press-fitting jaws TH16 & TH11.6

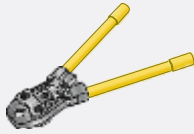

- > Press-fitting jaw TH11.6
- > Part No.: W025
- > PKU: 1 pce.
- > Weight/PKU: 2.0 kg



- > Press-fitting jaw TH16
- > Part No.: W024
- > PKU: 1 pce.
- > Weight/PKU: 2.1 kg



- > Cold shrinking tape
- > Part No.: Z1699
- > PKU: 1 pce. | Carton with 20 pcs.
- > Weight/PKU: 990 g
- > Roll: 50 mm x 15 m
- > 1 roll is sufficient for approx. 35 press-fit coupling connections (with a 50 % overlap)



Connecting pipes

Once the panels and the heating/cooling manifolds are installed, the panels are connected to the desired circuits. The pre-insulated Variotherm pipe 16x2 is used as the supply pipe. A permanent, tight connection is only guaranteed if original Variotherm system components are used:

- > VarioModular pipes
- > Variotherm calibration and chamfering tool
- > Variotherm press couplings + press tool

The press-fitting jaws and pressing tool must be checked at least once a year for correct operation by REMS or an authorised REMS customer service workshop.

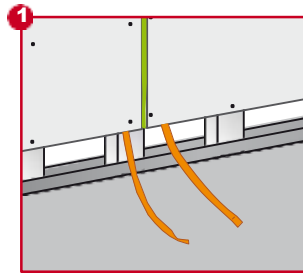

▲ Cut off the crushed pipe end at a right-angle

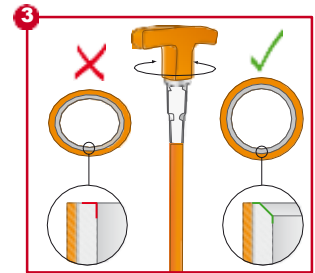
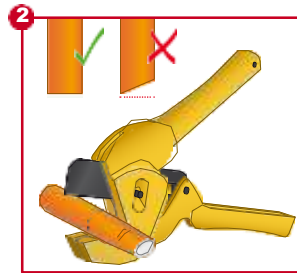

▲ Calibrate and chamfer the pipe

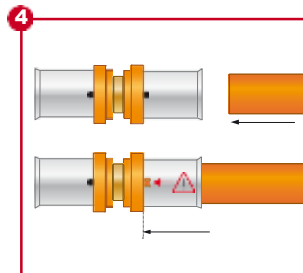

▲ Push on the press-fit coupling until it reaches the stop



▲ Pressing. The press-fit coupling must close fully.

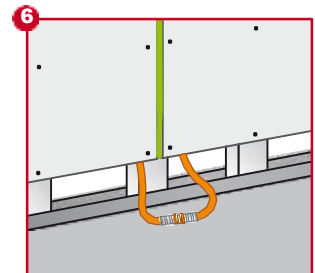

▲ Connected ModularPanels

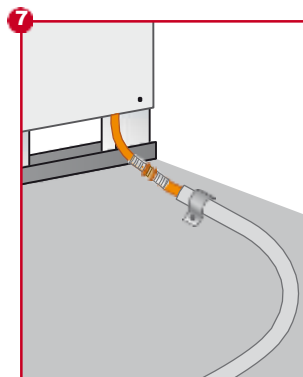

▲ Pre-insulated Variotherm pipe 16x2 connected with ModularPanel

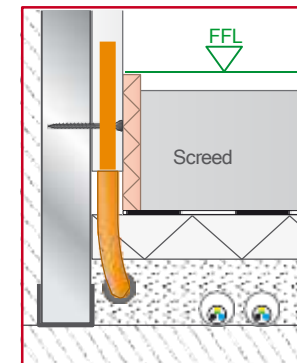

▲ Example of finished press-fit coupling in floor construction (new building)

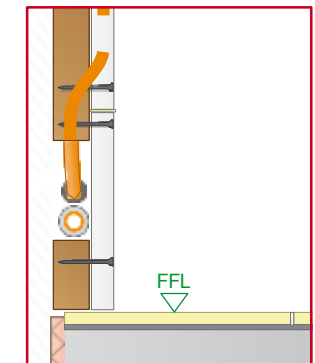

▲ Example of finished press-fit coupling with existing floor (rehabilitation)

Corrosion prevention measures/ dew-point monitoring

The connecting elements are to be protected (after the pressure test) in accordance with EN 1264 and compliance with ÖN H 5155 (e.g. with Z1699 cold shrink tape). This measure is also a prerequisite for effective dew-point monitoring in the case of cooling (see also Chapter 5.5)

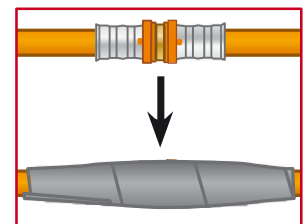

5.5 Dew-point monitor (on-site)

The dew-point sensor is fitted to the part of the pipe that is expected to dew first. This is normally the case on the flow inlet.

Care must be taken that there is a good thermal transition between the pipe and the sensor (use heat-conducting paste).

The supply pipes must be sufficiently fixed.

For further information on the dew point, see also Chapter 7.

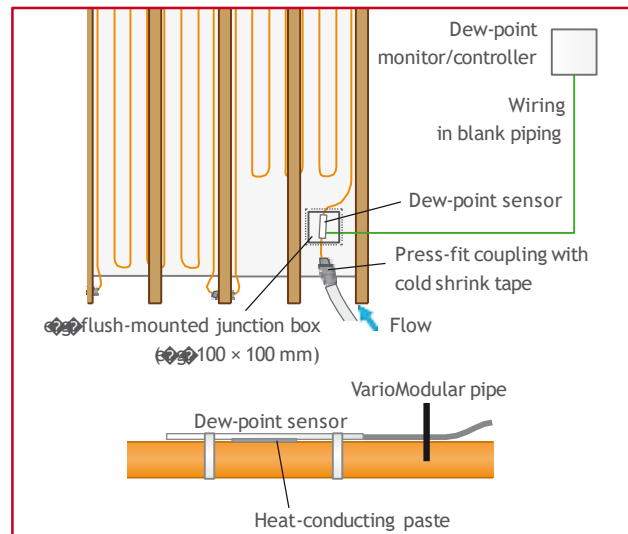

▲ Example Dew-point monitor (cooling)

5.6 VarioManifold

Advantages

- > Plastic manifold with internal air chambers for thermal insulation
- > Flexible conversion to thermostat operation
- > Pre-settable flow indicator in the flow (10-160 l/h) according to EN 1264-4, viewing glass can be cleaned
- > Optimised for **low-temperature** surface heating/cooling
- > Detachable 3-way ball valves on the flow and return bars
- > Venting option, flushing option via rotatable fill and drain cocks
- > Modular construction
- > Absolutely oxygen-tight
- > Designation labels
- > All parts self-sealing, manifold pressure-tested
- > Variable distance between flow and return bars

Pressure test

Once all circuits have been connected to the heating/cooling manifold, the system can be filled downstream of the manifold and pressurised. The pipes must be kept under water pressure prior to completion work (screeding, filling, painting, wallpapering, tiling), so that any damage becomes immediately visible. (Please see Chapter 9 for the protocol Leak-tightness test).

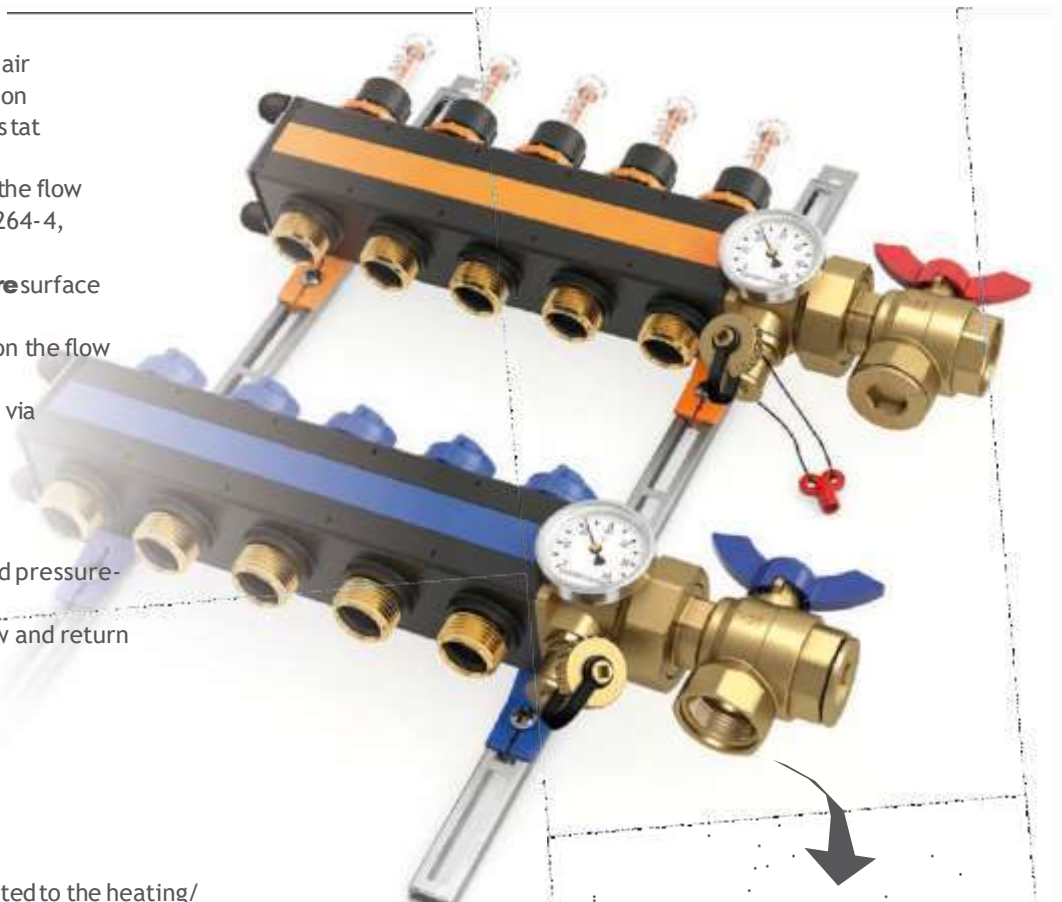

For details regarding the system and heating circuit pipes and the room temperature control please refer to the "DISTRIBUTION and CONTROL" planning and installation instructions



PDF

6 FINISHED SURFACE

6.1 Filling

After installation, the ModularPanels and the ModularExpansionPanels are filled using FERMACELL Joint filler or Fine surface treatment (or equivalent products). However, before this happens the set joint adhesive must be fully scraped off (the joint adhesive hardens after approx. 18 to 36 hours, depending on the room temperature). Attempting to remove joint adhesive that is still soft will result in smearing.

Caution: Filling may only be carried out after all wet work (wet screed, plastering, etc.) has dried!

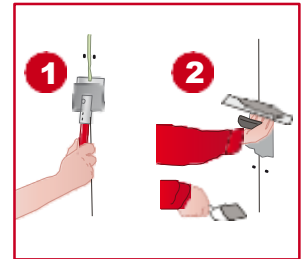

The following work is to be performed, depending on the surface quality required

Q1 – Minimum requirement	Q2 – Standard requirement	Q3 – High requirement	Q4 – Highest requirement
Necessary for: - Sealing layers and tiling	Necessary for: - Wallpaper and woodchip (medium or coarse grain) - Matt fillers (dispersion coating, thin plaster)	Necessary for: - Fine-textured wall coverings - Matt, non-textured wall coverings	Necessary for: - Smooth or fine-textured wall coatings - Metal or thin vinyl wallpapers - High-quality finishing technologies
Required work: - Scrapping off excess joint adhesive after hardening - Filling of visible fixings and adhesive joints with Fermacell Joint Filler or Fine Surface Treatment	Required work: - Q1 - Smooth and continuous filling of joints and fixings. No processing marks or filler burrs must remain visible. If necessary, the smoothed surfaces should be sanded.	Required work: - Q2 - If necessary broad filling of joints - Full-surface coating and sharp pull-off of entire surface with Fermacell Fine Surface Treatment or other suitable filling materials. If necessary, the smoothed surfaces should be sanded.	Required work: - Q2 - If necessary broad filling of joints - Full-surface coating and smoothing (e.g. with abrasive grid) of entire surface with Fermacell Fine Surface Treatment or other suitable filling materials.
	Settling of joints can't be ruled out, particularly under grazing light	Unevenness visible under grazing light, such as application marks on joints, cannot be excluded, but the unevenness is less than for Q2.	Unevenness at the joints must not be visible.

6.2 Fastening loads to the ModularWall

Light wall-mounted single loads: Light single loads parallel to the wall surface with low outreaches, such as (e.g.) pictures or decorations, can be fastened directly to the FERMACELL planking using commonly available fasteners without using an additional substructure. Suitable for this are (e.g.) nails, picture hooks with single or double nail mounts, or screws and dowels.

Light and medium-heavy cabinet loads: The listed loading values can be added when the dowel clearance is ≥ 500 mm. At lower dowel clearances, 50 % of the respective maximum permissible load for each dowel is used. The sum of the individual loads must not exceed 15 kN/m for walls and must not exceed 4 kN/m for free-standing single wall panels and double stud walls that are not connected to each other. Higher loads must be specially checked and approved.

Picture hooks ¹ fastened with nails	Permissible load ² per hook on ModularPanel (12.5 mm FERMACELL Panel)
	17 kg
	27 kg
	37 kg

Permissible loads for individual hanging on ModularPanel (12.5 mm FERMACELL Panel)	
	Cavity wall dowels ⁴ 50 kg
	Screw with continuous thread $\varnothing 5$ mm 30 kg

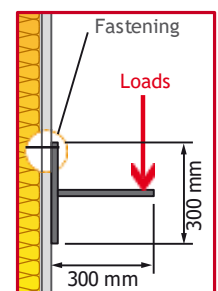

¹Breaking force of the hooks per brand. Hooks fastened corrosion-neutral only in the planking

²Safety factor 2 (constant load at rel. humidity up to 85 %)

³Introduced as per DIN 4103, safety factor 2

⁴Observe the instructions of the dowel manufacturer

6.3 Painting

Commonly available paints such as (e.g.) latex, emulsion or enamel paint can be applied to the ModularPanels. Mineral-based paints such as (e.g.) limewash and silicate paints must be approved by the manufacturer for use on gypsum fibreboards. The paint is usually applied in two steps.

6.4 Tiling

See also the appropriate standards for laying tiles, panels and mosaics.

Points to be observed:

- > The weight of the tiles (incl. adhesive) must not exceed 50 kg/m².
- > The surface of the modular panels must be at least Q1 before tiling/sealing (see table, section 6.4).
- > The moisture content of the ModularPanels must be less than 10% (min. 48 h at 70 % humidity and room temperature > 15 °C).
- > Sealing systems must be used on surfaces subject to the effects of moisture (see table below). The wall boundaries must be sealed using appropriate sealing tape.
- > A flexible adhesive is used to bond the tiles. A primer must be applied if this is stated by the adhesive manufacturer. This is particularly the case for flexible cement adhesives.
- > Flexible grouting mortar must be used for grouting.
- > After laying the tiles, boundaries with the walls are additionally sealed with silicone.

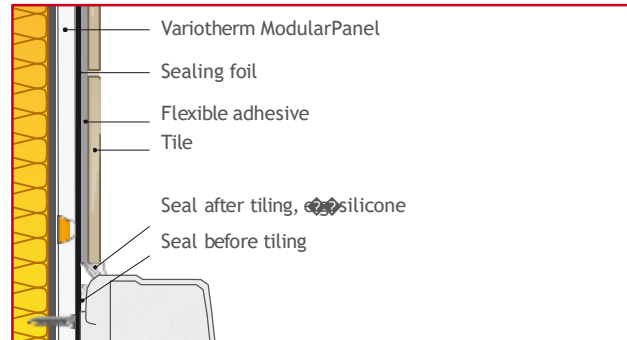

▲ Connections between shower/bathtub

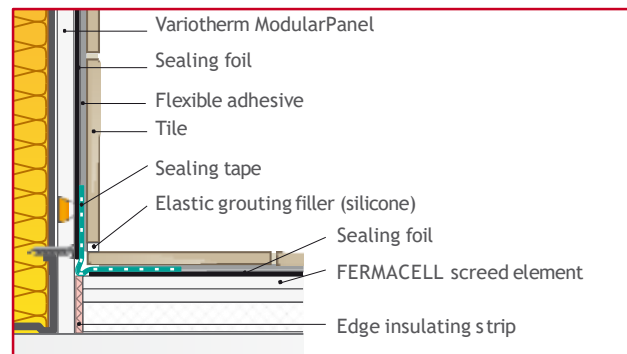

▲ Wall-screed structure in areas subjected to water loads

Use of primer and sealing system (compound sealing):

Stress group according to ÖN B 3407		Adhesive mortar with tile coverings	Primer	Sealing system
W1	Residential sector: living rooms, corridors, toilets, offices and the like	Calcium sulphate flexible adhesive mortar	Not required	Not required
		Cement flexible adhesive mortar	Required	Not required
W2	Residential sector: kitchen and rooms with similar usage Commercial sector: toilet systems	Only cement flexible adhesive mortar	In addition to the sealing system, when recommended by the manufacturer	Recommended
W3	Wall and floor surfaces without drainage (e.g. bathroom with shower tub higher than 20 mm above floor covering), toilet systems without floor drainage, porch			Required
W4-W6	Wall and floor surfaces with drainage (e.g. shower with flush drain at the same level as the floor) Swimming bath area, shower systems, industrial kitchen ...	No Modular Wall possible		

Product examples for primer or sealing system (compound sealing):

Manufacturer/Brand	Primer	Sealing system
FERMACELL	Deep primer	Waterproofing Application
Ardex	Ardex P51	Ardex 8 + 9
Cimsec	Gipsgrundierung	DichtflexDU15
PCI	Gisogrund	Lastogum
Schönox	Schönox KH	Schönox HA oder 1K-DS
Mapei	Primer G	Mapegum WPS
Weber	weber prim 801	weber sys 822
Ceresit	Lösungsmittelfreier Tiefengrund	Ceresit Dusch- & Badabdichtung

7.3 Heat output

t_f/t_r [°C]	t_{mH} [°C]	Heat output [W/m ²] at room temperature T_r					T_o [°C] (at $T_r = 20$ °C)
		$T_r = 15$ °C	$T_r = 18$ °C	$T_r = 20$ °C	$T_r = 22$ °C	$T_r = 24$ °C	
30/20	25.0	90	59	38	18	-	25
30/25	27.5	108	77	56	36	18	26
35/25	30.0	127	95	74	55	36	28
35/28	31.5	137	105	84	65	46	28
35/30	32.5	144	113	92	73	54	29
37.5/32.5	35.0	162	131	111	91	73	31
40/30	35.0	162	131	111	91	73	31
40/35	37.5	179	149	129	108	91	32
45/35	40.0	197	167	147	126	109	34
45/40	42.5	214	184	164	143	126	35
50/40	45.0	232	201	181	161	143	37
50/45 ¹	47.5	239	214	201	181	162	38

¹ The flow temperature must never exceed 50 °C

t_{mH} = mean hot water temperature = $\frac{t_f + t_r}{2}$ [°C] T_o = mean surface temperature [°C]
 T_r = room temperature [°C] t_f/t_r = flow temperature / return temperature [°C]

7.4 Cooling performance

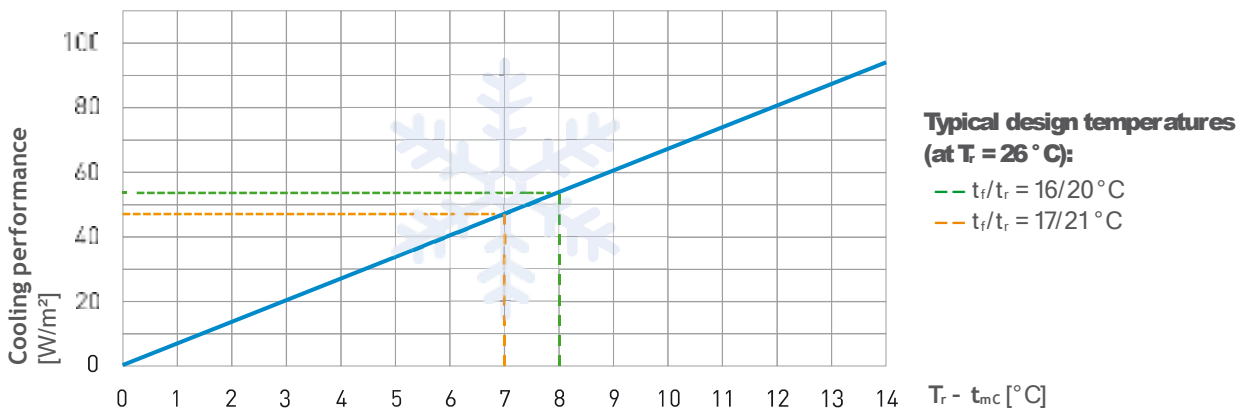

t_{mC} = Mean cooling water temperature = $\frac{t_f + t_r}{2}$ [°C]
 T_r = Room temperature [°C]
 t_f/t_r = Flow temperature / Return temperature [°C]

The flow temperature must be selected in such a way or it must be ensured that the surface temperature of the ModularPanel (room-side and cavity) and the pipe never reaches or falls below the dew-point temperature at any point. Whereby the mean surface temperature T_o corresponds approximately to the return flow temperature t_r .

Relative humidity [%rF]	Room temperature T_r [°C]				
	24	25	26	27	28
80 %					
70 %					
60 %	15.8	16.7	17.6	18.6	19.5
50 %	12.9	13.9	14.8	15.7	16.6
40 %	9.6	10.5	11.4	12.2	13.1

Dew-point temperature [°C]

Condensation can form on the pipes and surfaces if the flow temperature selected is too low. Control measures must be taken to prevent this (e.g. dew-point monitor, see also chapter 5.5).

7.5 Arrangement of the surfaces

Wall heating installations are used for heating occupied areas. For this reason, they should be evenly installed over the interior sides of exterior walls. At normal ceiling heights up to 3 m in buildings with good thermal insulation, designing the Modular Wall to a maximum height of 2 m above the finished floor level is sufficient. For a ceiling height of more than 3 m, (e. g. halls, stairwells, therapy areas) the wall heating installations must be designed higher than 2 m.

Experience has shown that radiant heat can be felt at a distance of up to 5 m from the heated wall. In larger rooms it is therefore advantageous to install a wall heating system on two opposing walls because the radiance effect on the body declines in proportion to the square of the distance.

With a good arrangement of the radiant heating surfaces and U- values (exterior wall) of $\leq 0.3 \text{ W/m}^2\text{K}$, the room air temperature can be reduced by up to $2 \text{ }^\circ\text{C}$ while retaining the same perceived temperature (comfort).

Seating and glass surfaces (e. g. windows) must be taken into consideration when choosing the arrangement of wall heating surfaces.

Furniture

Since the radiant heat should radiate into the living spaces, this is to be taken into consideration in the furniture planning. Wall fittings, full bookcases, built-in cupboards etc. should not be planned in front of wall heating systems. Desks, chests of drawers, open seats, small boxes, kitchen corner banks, pictures etc. usually present no problem. General rule of thumb: maximum of 15 % furnished area.

Tip: Beds (especially an open headboard) should not be placed directly in the radiation area of wall heating elements.

Guide values for dimensioning¹ the ModularWall:

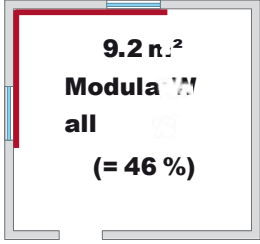
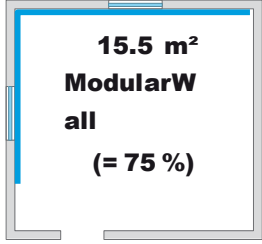
40 to 50 % of the room floor area	70 to 80 % of the room floor area
+ Heating o Slight cooling	+ Cooling + Heating + Energy saving due to lower flow temperature
Example, 20 m ² area:	Example, 20 m ² area:
 <p>9.2 m² ModularWall all (= 46 %)</p>	 <p>15.5 m² ModularWall all (= 75 %)</p>

If the wall is dimensioned for heating, experience has shown that it still achieves a good cooling effect (slight cooling) if this surface is used for cooling in summer. Conversely, the flow temperature can be reduced in winter when heating if the wall area is dimensioned for cooling. This saves energy!

Combination of heating systems

In the example below, the heating system has been adapted to suit the rooms: A floor heating system is planned for tiled rooms and wall heating surfaces are planned in the remaining rooms. A room thermostat for controlling the room temperature is planned for the kitchen, dining area and living room (influence of external heat sources from kitchen appliances, south-facing glass surfaces and tile stoves).

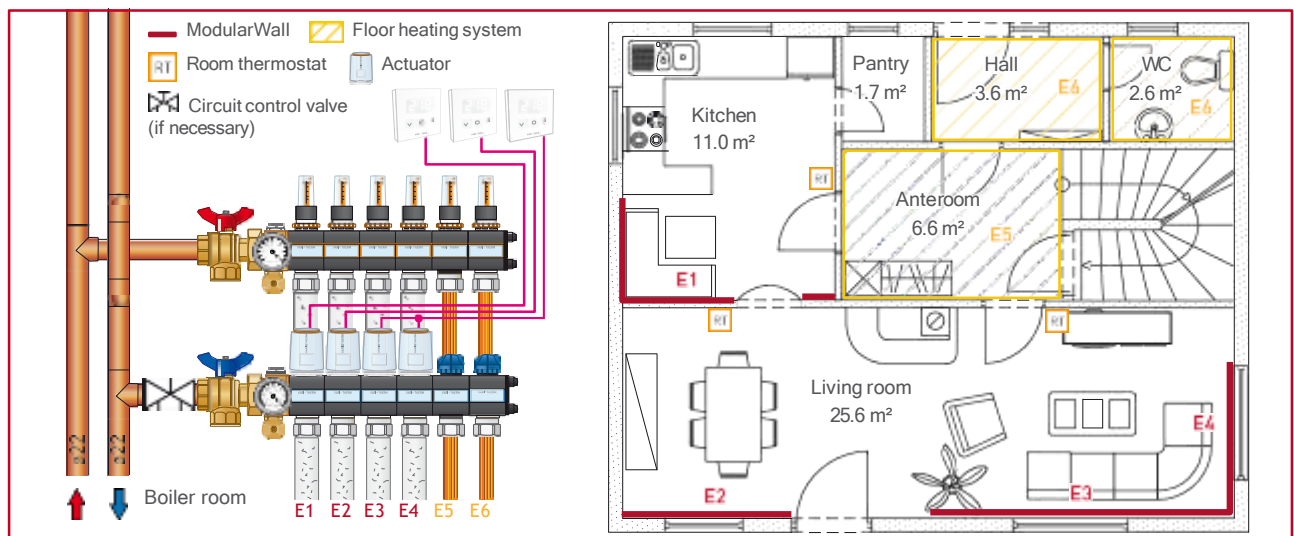

▲ Combination of heating systems, example single-family house (ground floor)

¹ Observe the heating/cooling load calculation for precise dimensioning of the area required!

7.6 Pressure loss

Example: The pressure loss of a 6.25 m² Modular wall heating (5 pcs. V020-100 at 1 heating circuit) is to be calculated. The desired flow/return temperature is 40/30 °C resulting in a heat output of 111 W/m² at a room temperature of 20 °C.

Calculation of the flow rate ω from the pressure loss diagram:

$$Q = 694 \text{ W (111 W/m}^2 \times 6.25 \text{ m}^2)$$

$$\Delta T = 10 \text{ K (} t_f - t_r = 40 \text{ K} - 30 \text{ K)}$$

$$c = 1.163 \text{ Wh/kgK (Specific heat capacity of water)}$$

$$m = Q \div c \div \Delta T$$

$$= 694 \text{ W} \div 1.163 \text{ Wh/kgK} \div 10 \text{ K} = 59.6 \text{ kg/h (l/h)}$$

59.6 l/h results, according to the diagram, in:

$$\text{Flow rate } \omega = 0.29 \text{ m/s}$$

$$\text{Pressure loss (Variotherm pipe 11.6x1.5)} = 205 \text{ Pa/m}$$

$$\text{Pressure loss (Variotherm pipe 16x2)} = 36 \text{ Pa/m}$$

Pipe length for 6.25 m² heating surface = 81 m

(1 pce. V020-100 = 16.2 m pipe, see table on page 18)

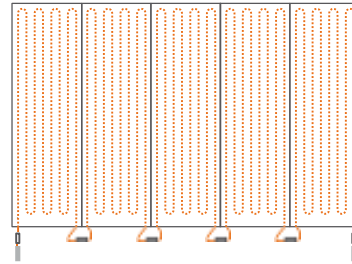

$$Q = m \times c \times \Delta T$$

Maximum flow rate per cooling/heating circuit of the VarioManifold:
160 l/h

Press-fit coupling	Coefficient of resistance ζ (Zeta)
11.6 x 11.6	7.2
16 x 11.6	6.9

- **Δp for 6.25 m² Modular Wall:** 205 Pa/m \times 81 m = **16605 Pa**
- **Δp for 15m pre-insulated VarioModular pipe 16x2:** 36 Pa/m \times 15 m = **540 Pa**
- **Δp for 4 pcs. press-fit couplings 11.6x11.6:** $\zeta \times \rho/2 \times \omega^2 = 7.2 \times 500 \text{ kg/m}^3 \times (0.29 \text{ m/s})^2 = 303 \text{ Pa} \times 4 \text{ pcs.} = **1212 Pa**$
- **Δp for 2 pcs. press-fit couplings 16x11.6:** $\zeta \times \rho/2 \times \omega^2 = 6.9 \times 500 \text{ kg/m}^3 \times (0.29 \text{ m/s})^2 = 290 \text{ Pa} \times 2 \text{ pcs.} = **580 Pa**$

$$\Delta p_{\text{Total}} = 16605 \text{ Pa} + 540 \text{ Pa} + 1212 \text{ Pa} + 580 \text{ Pa} = \mathbf{18937 \text{ Pa} = 1.89 \text{ mWC}}$$

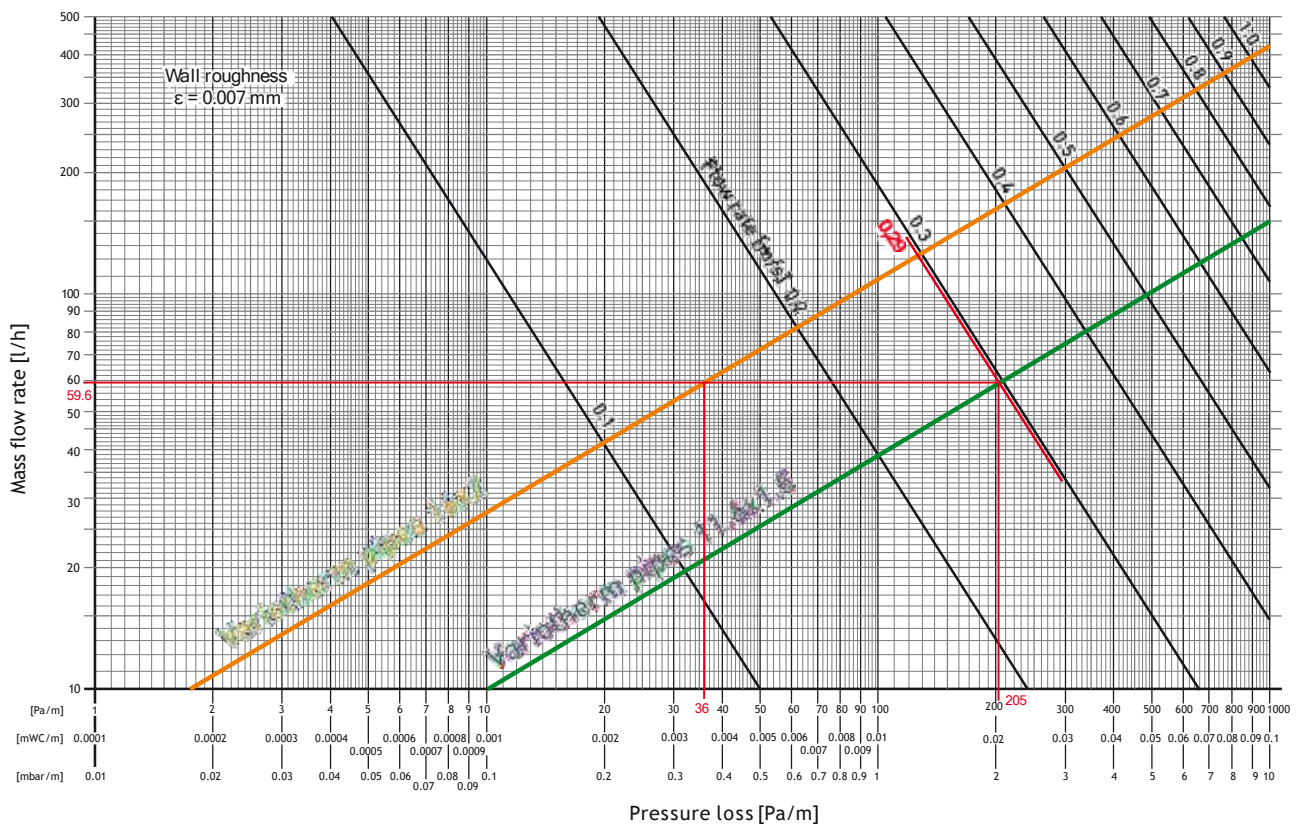

8 PROTOCOLS

8.1 Leak-tightness test in accordance with EN 1264-4

After installation and before completion work (screed, plastering, painting, wallpapering, tiling), the circuits of the Variotherm ModularWall must be checked for leak-tightness by means of a water pressure test. The test pressure should be min. 4 bar and max. 6 bar. Due to the initial pipe expansion, it may be necessary to re-pump the test pressure. If there is a risk of freezing, appropriate measures should be taken, e. g. use of antifreeze and controlling the building's temperature.

Construction project: _____

Building owner/occupant: _____

Client:

Heating installer: _____

Architect: _____

Others: _____

- › Installation of ModularPanels finished on: _____
- › Installation of pipe connections finished on: _____
- › Pressure test started on: _____ with test pressure _____ bar
- › Pressure test finished on: _____ with test pressure _____ bar
- › Start of completion work (plastering, painting, wallpapering, tiling) on: _____
- › The system water was treated (e.g. per ONORM H 5195-1) Yes No
- › System pressure during the completion work was _____ bar
- › Antifreeze was added to the system water Yes No
- › The system was checked for leak-tightness on: _____ and approved

Approval:

Building owner/Occupant/Client

Construction management/Architect

Heating installation technician

8.2 Functional heating (in compliance with EN 1264-4 or BVF¹)

The functional heating serves as verification and proof of the creation of a defect-free installation for the heating installer and/or drywall builder.

The functional heating is only carried out after the filling or gluing work has been completed. The filler or joint adhesive must have hardened.

Manufacturer's instructions must be observed.

The maximum calculated flow temperature must be maintained for at least 1 day.

Construction project: _____

Building owner/occupant: _____

Client:

Heating installer: _____

Architect: _____

Others: _____

Preheating of the Variotherm Modular Wall

› Completion work finished: _____

› Preheating started with constant max. calculated flow temperature: _____ | $t_f =$ _____ °C

› End of functional heating: _____

If there is a risk of freezing, appropriate measures should be taken (e.g. frost protection mode).

› The rooms were ventilated without draughts and all windows and external doors closed after switching off the surface heating and cooling system: Yes No

› Operating state and outdoor temperature on handover:

When switched off after the preheating phase, the ModularWall must be protected against draughts and from cooling down too quickly until it has cooled down completely.

Approval:

Building owner/Occupant/Client

Construction management/Architect

Heating installation technician

8.3 Commissioning

The flow temperature (heating water) of the ModularWall must not exceed $t_r = 50$ °C. The main stop valves at the distribution station and the heating circuit shut-offs must be opened. The entire system must be well vented. The circulation pump can be switched on after venting. After commissioning a Variotherm surface heating/cooling system can be considered maintenance-free.

(Subject to technical changes.)

¹ BVF = Bundesverband Flächenheizungen und Flächenkühlungen e.V.

ENJOY THE COMFORT & SAVE ENERGY

That's why our customers love us:
Heating and cooling optimised for COMFORT in all rooms!
Fast and friendly service, ANSWERS backed up with expertise!
Always in tune with the latest technology, INNOVATION guaranteed!
Everything CLEAR and SIMPLE, in writing of course!
PROFESSIONALISM at all times, from the first contact to the reference list!

VARIOTHERM SINCE 1979

Variotherm is an Austrian model plant with hundreds of partners in Austria, Europe and around the world.



VBOOK6_EN | 2/2023



Variotherm Partner:

VARIOTHERM / კლიმაკომფორტ
თბილისი / დიდი დილომი
დემეტრე თავდადებულის N-26

მზ:00995-595121265
info@climacomfort.co.uk
www.climacomfort.co.uk

All rights pertaining to distribution and translation, in whole or in part, including film, radio, television, video recording, Internet, photocopying and reprinting, are reserved. Subject to mistakes and printing errors. Misprints and errors excepted.